

Black Box Data Recorder ***(MUX-8A)*** ***Operating and Installation Instructions***

II 1221991

12/21/99
Rev. B: 7/30/09

You must read this manual before installing or operating the instrument. This manual contains warranty and other information that may affect your decision to install this product and/or the safety of your aircraft.

Black Box

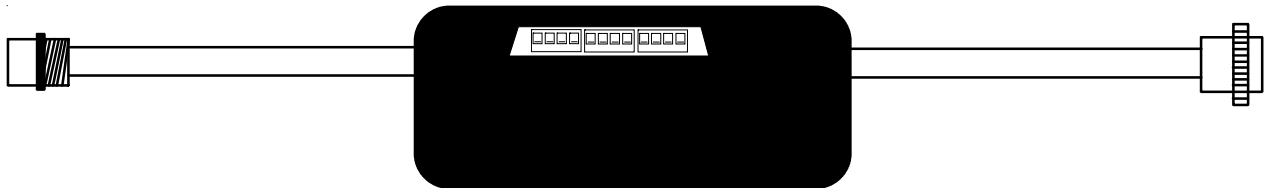

(Mounts under the aircraft instrument panel)

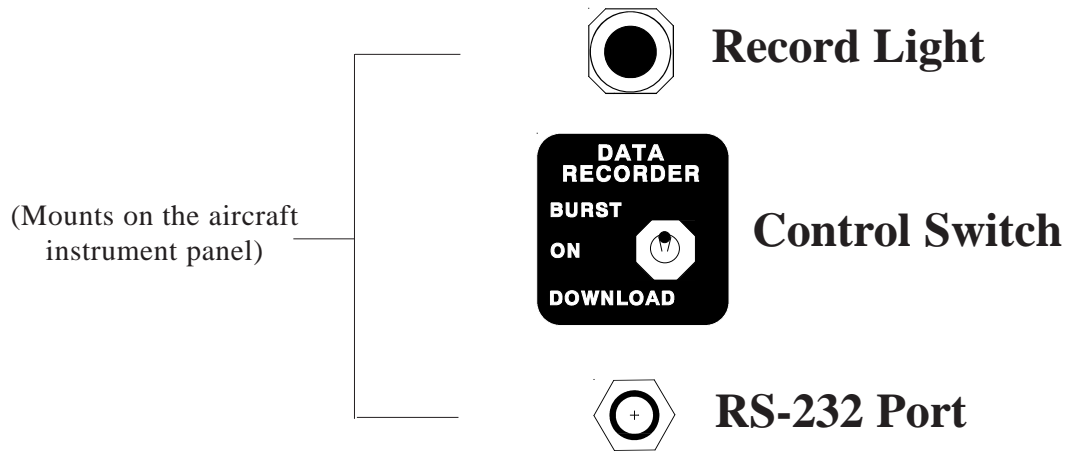

S/N: _____



Electronics International Inc. ®

63296 Powell Butte Hwy • Bend, OR 97701 • (541) 318-6060 • Buy-EI.com



Important Notice

******* MUST READ *******

If you think it is not important to read this manual, you're wrong! This manual contains important installation information that may affect the safety of your aircraft, delay your installation or affect the operation of your instrument. You Must read this manual prior to installing your instrument.

Read the Warranty / Agreement. There is information in the Warranty / Agreement that may alter your decision to install this product. If you do not accept the terms of the Warranty / Agreement, do not install this product. This product may be returned for a refund. Contact Electronics International inc. for details.

It is possible for any instrument to fail thereby recording inaccurate high, low or jumpy readings. Therefore, you must be able to recognize inaccurate data. Do not use inaccurate data to evaluate the health of your engine.

Contents

Warranty	2
Operating Instructions:	3
General Description:	3
Control Switch:	3
Record Light:	4
Data Storage:	4
Event Warning Line:	5
Input Channels:	5
Setting the Dip Switches in the Data Recorder:	6
A. Enable/Disable an Input Channel	6
B. Enable/Disable the Time-out Period	6
C. Setting the Storage Time Interval	6
Download Data Format:	7
Xmit Format for the Professional Data Recording Software:	8
Installation Instructions:	9
A. Important Information and Initial Checkout:	9
B. Mount the MUX-8A Control Switch:	9
C. Mount the MUX-8A Record Light:	10
D. Mount The RS-232 Connector:	10
E. Setting the DIP Switches:	10
F. Mount the MUX-8A Black Box:	10
G. Connect the 9-Pin Male Wire Harness and Route Wires:	11
H. Connect the 9-Pin Female Wire Harness and Route Wire:	12
I. System Check-out:	13
Specifications and Operating Features	14
Wiring Diagram	15
RS-232 Data Sheets	16 and following

Warranty / Agreement

Electronics International Inc. warrants this instrument and system components to be free from defects in materials and workmanship for a period of one year from the user invoice date. Electronics International Inc. will repair or replace any item under the terms of this Warranty provided the item is returned to the factory prepaid.

1. This Warranty shall not apply to any product that has been repaired or altered by any person other than Electronics International Inc., or that has been subjected to misuse, accident, incorrect wiring, negligence, improper or unprofessional assembly or improper installation by any person. **This warranty does not cover any reimbursement for any person's time for installation, removal, assembly or repair.** Electronics International retains the right to determine the reason or cause for warranty repair.
2. This warranty does not extend to any machine, vehicle, boat, aircraft or any other device to which the Electronics International Inc. product may be connected, attached, interconnected or used in conjunction with in any way.
3. The obligation assumed by Electronics International Inc. under this warranty is limited to repair, replacement or refund of the product, at the sole discretion of Electronics International Inc.
4. Electronics International Inc. is not liable for expenses incurred by the customer or installer due to factory updates, modifications, improvements, upgrades, changes, or any other alterations to the product that may affect the form, fit, function or operation of the product.
5. Personal injury or property damage do to misinterpretation or lack of understanding this product is solely the pilots responsibility. The pilot **must** understand the operation of this product before flying the aircraft. Do not allow anyone to operate the aircraft that does not know the operation of this product. Keep the Operating Manual in the aircraft at all times.
6. E. I. Inc. is not responsible for shipping charges or damages incurred under this Warranty.
7. No representative is authorized to assume any other liability for Electronics International Inc. in connection with the sale of Electronics International Inc. products.
8. **If you do not agree to and accept the terms of this warranty, you may return the product for a refund.**

This Warranty is made only to the original user. **THIS WARRANTY IS IN LIEU OF ALL OTHER WARRANTIES OR OBLIGATIONS: EXPRESS OR IMPLIED. MANUFACTURER EXPRESSLY DISCLAIMS ALL IMPLIED WARRANTIES OF MERCHANTABILITY OR FITNESS FOR A PARTICULAR PURPOSE. PURCHASER AGREES THAT IN NO EVENT SHALL MANUFACTURER BE LIABLE FOR SPECIAL, INCIDENTAL OR CONSEQUENTIAL DAMAGES, INCLUDING LOST PROFITS OR LOSS OF USE OR OTHER ECONOMIC LOSS. EXCEPT AS EXPRESSLY PROVIDED HEREIN, MANUFACTURER DISCLAIMS ALL OTHER LIABILITY TO PURCHASER OR ANY OTHER PERSON IN CONNECTION WITH THE USE OR PERFORMANCE OF MANUFACTURER'S PRODUCTS, INCLUDING SPECIFICALLY LIABILITY IN TORT.**

Black Box Data Recorder

Operating Instructions

General Description:

The Black Box Data Recorder (model: MUX-8A) is an 8-channel data recorder packaged in a 4.1" by 2.6" by 1.7" black box which is tie wrapped under the instrument panel. Also, there is a Control Switch, Record Light and RS-232 Port that may be mounted on the aircraft instrument panel. Channels 1 through 7 on the Data Recorder are designed to receive the RS-232 (5V) output signals from any Electronics International Instrument equipped with the RS-232 (5V) option. E.I.'s Ultimate Bar Graph Engine Analyzer (model UBG-16) comes with a RS-232 output. Other E.I. Instruments must to be ordered with the RS-232 option to be able to operate with the Data Recorder. Channel 8 on the Data Recorder is designed to receive RS-232 moving map data from a GPS instrument (most GPS instruments output moving map data).

Any channel on the Data Recorder can be enabled or disabled with the DIP switches found in an opening on the side of the Data Recorder's black box. The Data Recorder scans the enabled input channels, formats the incoming data and stores the data to internal memory. Also, as the data is stored in memory it is transmitted to the RS-232 Port. This allows data to be transmitted directly to a P.C. using Electronics International's Professional Data Recording Software (DRS-18).

Control Switch:

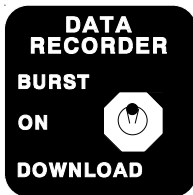

If the Control Switch is placed in the "ON" position, the Data Recorder will store data to internal memory according to the Storage Time Interval setting (1, 3, or 6 minutes) set by the DIP switches found in an opening on the side of the Data Recorder's black box.

If the Control Switch is placed in the "BURST" mode, the Data Recorder will store data as fast as it can. The Storage Rate is determined by totaling the Transmit Rates of the instruments to which its connected. The Transmit Rate for various E.I. Instruments are shown below:

<u>Instrument:</u>	<u>Transmit Rate:</u>
UBG-16 (comes with RS-232 output)	5 seconds
US-8A w/ RS-232 (5V) Option	5 seconds or more (varies with scan rate)
R-1, M-1 and ASC-5A w/ RS-232 (5V) Option	1/3 second
OPT-1 w/ RS-232 (5V) Option	1/4 second
FP-5L w/ RS-232 (5V) Option	1/2 seconds
Most GPS Units	1 to 3 seconds

If you experience an engine problem and would like a snap shot of your engine's parameters for any reason, place the Data Recorder into the "BURST" mode. With only the UBG-16 connected to the Data Recorder, data will be stored every 5 seconds. Note: If you leave the Data Recorder in the "BURST" mode for a long period of time, you will use up a large portion of the available memory recording this one event.

The "DOWNLOAD" position on the Control Switch is used to download data from the Data Recorder's memory to a P.C. The use of this switch position will be covered later in this manual.

Record Light:



Any time the Data Recorder is storing data to its internal memory, the Record Light will come on. This light is only on for the time it take to receive data from the activated channels (i.e., with only one channel activated and the UBG-16 connected to that channel, the Record Light will come on for 5 seconds each time data is recorded). In the "BURST" mode data is being recorded continuously and the Record Light will be on all the time.

Data Storage:

Data is stored into the Data Recorder's internal memory in a ring or loop fashion. Once the last memory cell is used, the Data Recorder will store the latest data over the top of the oldest data. In this way you will always have the last 100 to 600 hours of data stored in memory (depending on the Storage Capacity of the Data Recorder).

The amount or capacity of data the Data Recorder can store to internal memory is dependent on the total of the Bytes Required per Record for each of the instruments connected to the Data Recorder and the Storage Time Interval selected (1, 3, or 6 minutes). Use the following formula and chart below to calculate the Storage Capacity of the Data Recorder for your configuration.

$$\text{Storage Capacity (in hours)} = \frac{262,130}{\text{Total Bytes Required per Record (see below)}} \times \frac{\text{Storage Time Interval (1, 3 or 6 min.)}}{60 \text{ (min/hr)}}$$

Instrument:	Bytes Required per Record
MUX-8A Internal Clock and Event Warning Line	6
UBG-16 or US-8A	32
R-1 or M-1	2
OPT-1	4
FP-5L	6
ASC-5A	8
GPS	27

MS12120801

Example: With the UBG-16 and the R-1 (w/RS-232 option) connected to the Data Recorder, the total Bytes Required per Record is $6 + 32 + 2 = 40$. If we set the Storage Time Interval to 6 minutes, the Storage Capacity of the Data Recorder = $(262,130 / 40) \times (6 / 60) = 655$ hours.

In the "BURST" mode the Data Recorder stores data as fast as it can. To calculate the Storage Capacity of the Data Recorder when operated in the "BURST" mode, use the following formula:

$$\text{Storage Capacity (in hours) (BURST mode)} = \frac{262,130}{\text{Total Bytes Required per Record}} \times \frac{\text{Total Transmit Rate of Instruments (in sec.)}}{3600 \text{ (sec/hr)}}$$

The Data Recorder uses EEPROM memory ICs. This type of memory **does not** require any batteries or power to keep the memory alive. Data will remain in the memory ICs for a minimum of 40 years.

Event Warning Line:

The Data Recorder provides an Event Warning Line that may be used to record an event or condition. The moment this line is pulled to ground, a recording is initiated and "(ON)" is stored in the Event Warning field. The brackets "()" around the "ON" are used to indicate that a change in the Event Warning Line has occurred. If this line continues to stay at a low level, "ON" (without brackets) will be stored to the Event Warning field and the Data Recorder will store data every minute, regardless of the Storage Time Interval setting. The moment the Event Warning Line goes to a high level, a recording is initiated and "(OFF)" will be stored in the Event Warning field. If this line stays at a high level, "OFF" (without brackets) will be stored to the Event Warning field and the Data Recorder will store data at a rate determined by the Storage Time Interval setting.

All E.I. Instruments with an RS-232 output provide an External Warning Line. This line will go to a low level when a programmed limit is reached or a problem occurs. An instrument's External Warning Line can be connected to the Event Warning Line on the Data Recorder to trigger the recordings described above.

Input Channels:

The Data Recorder has 8 input channels. Channels 1 through 7 are designed to receive RS-232 (5V) data from various Electronics International instruments. Also, channels 1 through 7 can be used to receive the RS-232 (5V) signal from another Data Recorder for cascade operation. Cascade operation allows data to be received from an unlimited number of E.I. Instruments.

Channel 8 is designed to receive RS-232 moving map data from a GPS Instrument (most GPS Instruments transmit moving map data). See the GPS RS-232 Data Sheet at the back of this manual for data information.

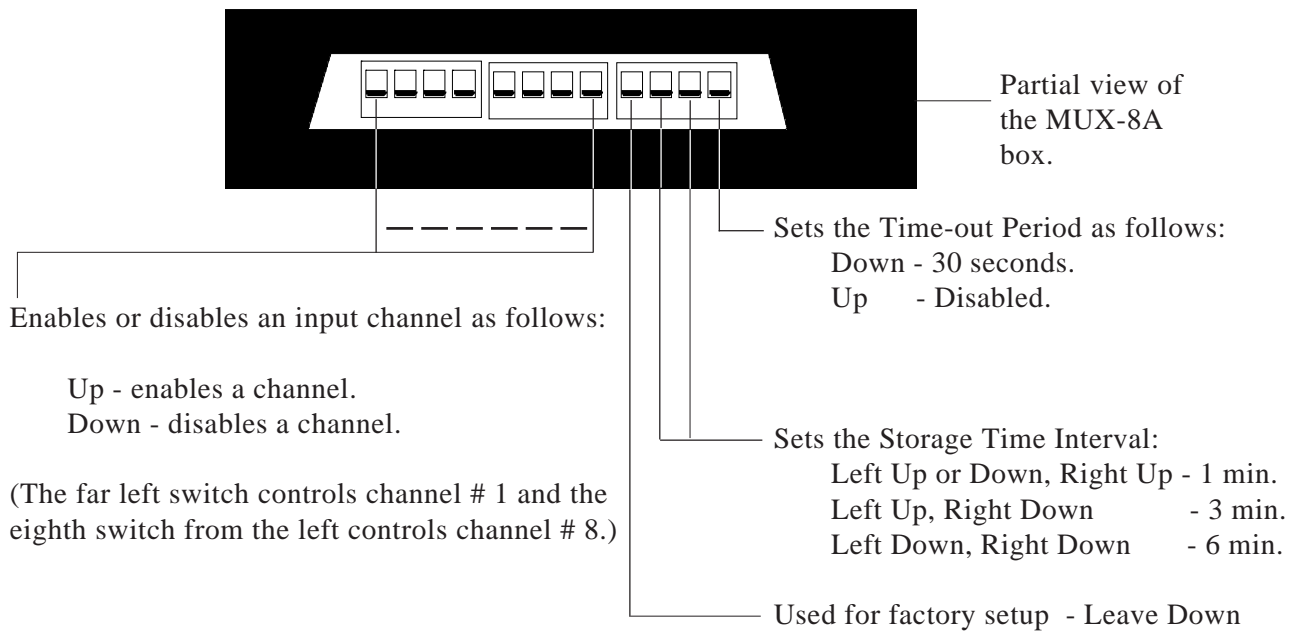

Setting the DIP Switches on the Data Recorder:

The 12 DIP Switches located on the side of the Data Recorder perform the following functions:

- A. Enable/Disable an input channel** - The first 8 DIP switches, as shown in the diagram, allow any one of the 8 input channels to be enabled or disabled. The Data Recorder starts its scan with channel # 1. If this channel is enabled, the Data Recorder will wait for incoming data. If this channel is disabled, the Data Recorder will skip to channel # 2. The Data Recorder performs this logic for each channel.
- B. Enable/Disable the Time-out Period** - If the Time-out feature is set for 30 seconds, the Data Recorder will monitor an enabled channel for 30 seconds. If data is not received within 30 seconds, an error code will be placed in the RS-232 data string and the Data Recorder will skip to the next enabled channel. Setting the Time-out Period for 30 seconds allows the Data Recorder to keep scanning in the event there is a problem with an instrument or data line. Otherwise, the Data Recorder will wait for data indefinitely.
- C. Setting the Storage Time Interval** - The Storage Time Interval may be set to 1, 3, or 6 minutes. The Storage Time Interval determines the Storage Capacity of the Data Recorder.

Downloading Data from Memory:

The Data Recorder will download data through the RS-232 Port to a P.C. The data is in a comma delimited format. Electronics International's Data Recording Software (DRS-1) is designed to receive and record this data to a file. Once the data has been stored on a P.C., any data base or spreadsheet program may be used to read, organize, graph and manipulate this data. To download data, perform the following steps:

1. Plug the RS-232 Cable into your laptop computer and into the MUX-8A RS-232 Port on your aircraft instrument panel.
2. Turn the aircraft power on.
3. Run the Data Recording Software program (DRS-1) on your laptop.
 - a. Verify Date and Time.
 - b. Setup the file name.
 - c. Select the Com. Port.
 - d. Push the Control Switch to the "DOWNLOAD" position and hold. When "READY" shows on the DRS-1 top screen, release the Control Switch. The Data Recorder will download all of the MUX-8A stored data to the designated file on the laptop. If the Data Recorder's memory is full, it will take approximately 25 minutes to download and process all of the data (depending on the speed of your P.C.). While the data is being downloaded the Record Light will blink. When the downloading of data is complete, the DRS-1 status screen will say "Processing Data" and the Record Light will stop blinking. After the data has been processed, the DRS-1 status screen will say "Download Completed." Pushing the Control Switch to the "BURST" position will stop the download and start the processing of data.
4. When finished, turn off the aircraft power and exit the DRS-1 program.

Download Data Format:

Data is downloaded beginning with the oldest data, followed by the newest. The data is organized in records. Each line represents a record. A comma is used to separate each field in a record. As an example, one channel on a Data Recorder was connected to a UBG-16 and one sample record (shown below) was generated.

12/21/99 16:03:15,OFF,1456,0356,1420,0362,1487,379,1412,0321,1461,0350,1497,0407,2430,0242

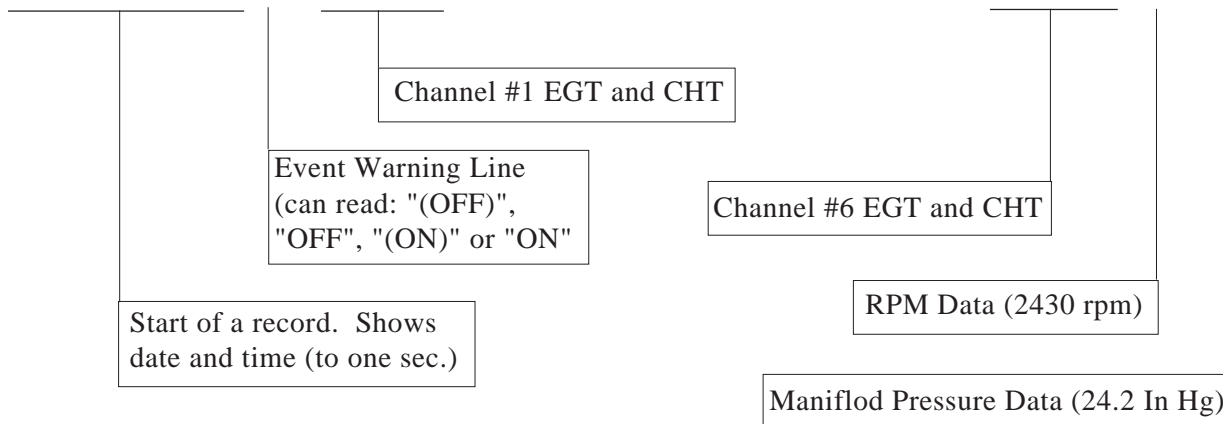

If an error occurs on any channel due to a problem in an instrument or data line, "ERROR CH1", "ERROR CH2", "ERROR CH3", etc. will be placed in the record, indicating on which channel the error occurred.

Clearing the MUX-8A's Memory:

To clear the MUX-8A's memory perform the following:

1. Turn aircraft power off.
2. Set the "Factory Setup DIP Switch" up. When this switch is up, the clear memory feature is enabled. This switch may be left in the up position.
3. Hold the "Control Switch" in the Download position and turn aircraft power on.
4. After five seconds the "Record Light" will come on, memory is cleared. If your monitoring the RS-232 out, the screen will display "Memory Ceared."

Transmit Format for the Professional Data Recording Software:

The following information is for those people intending to use the Data Recorder with Electronics International's Professional Data Recording Software (DRS-18). The difference between the transmitted data and the downloaded data is that the transmitted data comes from the instruments connected to the Data Recorder and is recorded as it occurs (real time) to a P.C. Downloaded data comes from the Data Recorder's internal memory and represents data that was recorded from instruments at an earlier date.

As the Data Recorder scans each enabled channel, it transmits a string of data called a record out the RS-232 port. The DRS-18 software is designated to receive, format and store this data as it occurs. A record starts with the "BBDR" declaration and ends with a carriage return (Cr) line feed (Lf). A comma is used to separate each field in a record. The number of fields in a record depends on how many channels on the Data Recorder are enabled and how many fields of data each instrument connected to the Data Recorder transmits. The transmitted data for a specific instrument may be found on the RS-232 (5V) Option page shipped with each instrument or at the back of this manual. A sample record is shown below.

BBDR,OFF,{Channel #1 Data},{Channel #2 Data}, ----- ,{Channel #7 Data},GPS, {GPS Data} Cr Lf

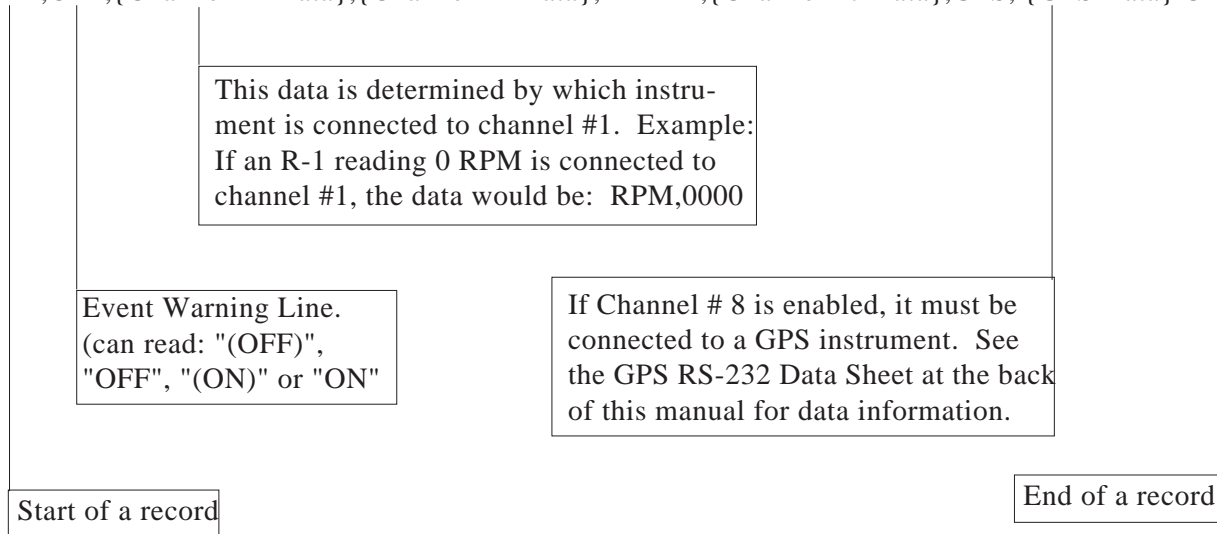

If an error occurs on any channel due to a problem in an instrument or data line, "ERROR CH1", "ERROR CH2", "ERROR CH3", etc. will be placed in the record, indicating on which channel the error occurred.

MUX-8A

Installation Instructions

A. Important Information and Initial Check Out:

- A. **The installer and aircraft owner must read the Warranty before starting the installation.** There is information in the Warranty that may alter your decision to install this device. **If you do not accept the terms of the Warranty, do not install this device.**
- B. **If you are not an FAA Certified Aircraft Mechanic familiar with the issues of installing aircraft instruments, Do Not attempt to install this device. The installer should use current aircraft standards and practices to install this unit (refer to AC 43.13-2A).**
- C. This device's installation may be considered a minor alteration (as is true for clocks, radios, intercoms, headsets, audio panels, encoders, etc.). Installation of this device can be accomplished utilizing FAA acceptable methods, techniques and practices covered under AC 43.13-2A. This is a requirement under FAR Part 1 to qualify as a minor alteration. This instrument does not "appreciably" affect weight and balance or electrical load as described in FAR Part 1 and FAR 43 Appendix A (another requirement to qualify as a minor alteration). The MUX-8A meets the environmental requirements of DO-160C. The MUX-8 is manufactured in Electronics International's FAA PMA/TSO approved manufacturing facility. If the installer determines that installing this device is a minor alteration, he/she must note it as such in the aircraft log book. Example: "**2/6/00 Installed Electronics International's MUX-8A as a minor alteration. This device was installed in accordance with Installation Instructions II 1221991 dated 12/21/99 and AC 43.13-2A.**" A minor alteration does not require a 337. **Resolve any possible FAA approval issues prior to starting the installation.**
- D. **Read these Installation Instructions in their entirety and resolve any issues you may have before starting the installation.** This may eliminate any delays once the installation is started.
- E. **THIS INSTALLATION MAY REQUIRE SOME PARTS UNIQUE TO YOUR AIRCRAFT THAT ARE NOT SUPPLIED IN THE KIT.** Read the Installation Instructions and acquire all the parts necessary to install this instrument **before starting the installation.**
- F. Before starting the installation make sure the Control Switch and Record Light will fit within the intended location and can be installed without obstructing the operation of any controls.

B. Mount the MUX-8A Control Switch:

Locate the Control Switch in the MUX-8A kit. Remove the switch from the faceplate. Find an appropriate mounting location on the aircraft instrument panel for the Control Switch. The Switch will require 3/4" clearance behind the aircraft instrument panel.

Drill a 1/4" hole in the aircraft instrument panel for the MUX-8A Control Switch and faceplate. Mount the Switch from behind the aircraft instrument panel. The Switch should be mounted with the yellow wire "Down." The down position should be momentary.

C. Mount the MUX-8A Record Light:

Locate the Record Light in the MUX-8A kit. Drill a 5/16" hole in the aircraft instrument panel for the Record Light and mount the light from the front of the aircraft instrument panel. If you find the Record Light too bright for night operation, you may want to wire the Record Light's red wire to the aircraft's panel light rheostat. Also, you can put a 7.5K ohm 5% 1/4 watt resistor in series with the Record Light's red wire to dim this light. The larger the value of the resistor, the dimmer the light will be.

D. Mount The RS-232 Connector:

Locate the RS-232 connector in the MUX-8A kit. Drill a 1/4" hole in the aircraft instrument panel for the RS-232 connector and mount the connector from behind the aircraft instrument panel.

E. Set the DIP Switches:

Set the 12 DIP Switches located on the side of the MUX-8A Black Box as described in the Operating Instructions of this manual.

F. Mount the MUX-8A Black Box:

Tie wrap the MUX-8A Black Box to a wire bundle under the aircraft instrument panel using two tie wraps (one on each side of the box). The slot on the side of the box may need to be accessible to allow for configuration of the MUX-8A as described in the Operating Instructions portion of this manual.

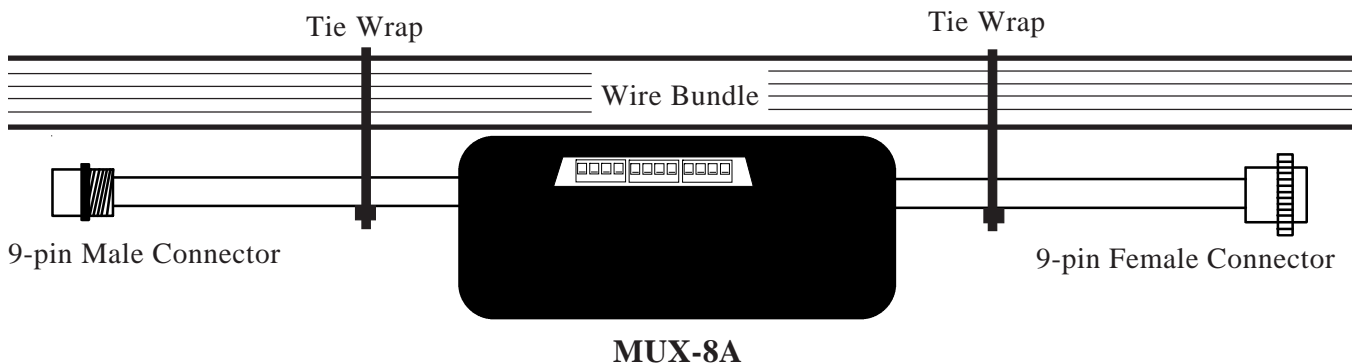

G. Connect the 9-Pin Male Wire Harness and Route Wires:

Connect the 9-Pin Male Wire Harness to the MUX-8A and route the wires as shown below. Tie wrap all the wires so they do not obstruct the freedom of travel of any controls. See the MUX-8A Wiring Diagram at the back of this manual.

MUX-8 9-Pin Male Connector		
Wire Color	Channel	Connect to:
Brown	1	E.I. Inst. RS-232 (5V) Line
Red	2	E.I. Inst. RS-232 (5V) Line
Orange	3	E.I. Inst. RS-232 (5V) Line
Yellow	4	E.I. Inst. RS-232 (5V) Line
Green	5	E.I. Inst. RS-232 (5V) Line
Blue	6	E.I. Inst. RS-232 (5V) Line
Violet	7	E.I. Inst. RS-232 (5V) Line
Gray	8	GPS RS-232 Moving Map Output

MUX-8A 9-Pin Male Connector

Connecting Cable Harness, Back View (wire side)

OR

MUX-8A Connector, Front View

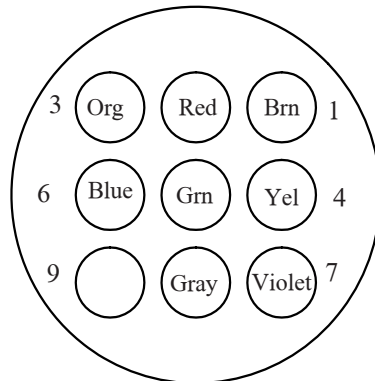

Note: See Wiring Diagram for hook up information.

H. Connect the 9-Pin Female Wire Harness and Route Wires:

Connect the 9-Pin Female Wire Harness to the MUX-8A and route the wires as shown below. **Tie wrap all the wires so they do not obstruct the freedom of travel of any controls.** See the MUX-8A Wiring Diagram at the back of this manual.

MUX-8 9-Pin Female Connector		
Wire Color:	Description:	Connects to:
Black	Ground	To Ground.
Red	Power	To 12 or 24-Volt Bus via one amp fuse.
Orange	Event Warning Line	To an E.I. Instrument warning line, device or switch that grounds to activate (see below for further details).
White/Red	Record LED Line	To Record Light White/Yellow wire.
Brown (Marked "To SWT")	Download Control Line	To Control Switch Brown wire.
Yellow (Marked "To SWT")	Burst Control Line	To Control Switch Yellow wire.
Blue (Marked "To RS-232")	RS-232 Output	To RS-232 Port Blue wire.
Black (Marked "To RS-232")	RS-232 Ground	To RS-232 Port Black wire.
Green	RS-232 (5V) Output	To Another MUX-8A for cascade operation.

Connecting the Event Warning Line to more than one E.I. Instrument:

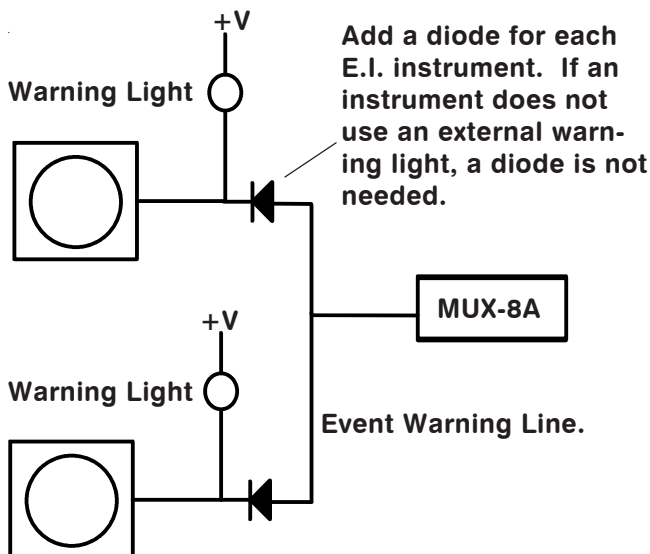

MUX-8A 9-Pin Female Connector

Connecting Cable Harness, Back View (wire side)
OR
MUX-8A Connector, Front View

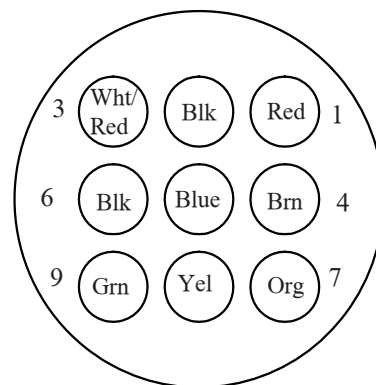

I. System Check-out:

1. Turn the aircraft power on and place the Control Switch in the "BURST" position. The Record Light should come on and stay on. If it does not, check the power and ground connections, Record Light connections and the Control Switch connections. Also perform the following:
 - a) To test the Record Light, remove the Record Lights white/yellow wire from the MUX-8A and short this wire to ground. The Record Light should come on.
 - b) With the Control Switch in the "BURST" position the MUX-8A yellow wire should be grounded. Measure this wire with a volt meter.
2. Place the Control Switch from the "BURST" to the "ON" position. The Record Light should go out in 10 seconds or less (this time depends on the total Transmit Rate for all the instruments connected to the MUX-8A). If the Record Light is staying on for approximately 30 seconds (the time-out period), verify that the proper channels are enabled. Also, check the RS-232 connections between the MUX-8A and the E.I. Instruments. Troubleshoot by enabling only one channel at a time.
3. Place the Control Switch in the "ON" position. Every 1,3, or 6 minutes (depending on the Storage Time Interval) the Record Light should come on for 5 to 10 seconds. Note: If you connected the Event Warning Line to one or more E.I. Instrument External Warning Control Lines and one of these instruments is lighting a warning light, the Record Light will come on every minute regardless of the Storage Time Interval setting. Check for proper operation with the E.I. Instrument warning lights on and off.

Specifications and Operating Features

Model:

MUX-8A (Data Recorder)

Dimensions:

Box - 4.1" x 2.6" x 1.7" depth

Weight:

Control Box - 7.7 Oz.

Environmental:

Meets DO-160C

Power Requirements:

7.5 to 35 Volts, 1/10 Amp.

Input Lines 1 through 7:

Receives an RS-232 (5V) signal at 9600 baud, 8 data bits, 1 start bit (logic low) and 1 stop bit (logic high 5-volts). Data must be terminated with a carriage return (0Dh) line feed (0Ah).

Input Line 8:

Receives a GPS RS-232 moving map signal at 9600 baud, 8 data bits, 1 start bit (logic high) and 1 stop bit (logic low). All logic levels must meet the EIA RS-232 specifications.

Event Warning Line:

An "open" on the Event Warning Line will generate an "OFF" in the MUX-8A transmitted record and data will be stored at a rate determined by the Storage Interval setting (1, 3, or 6 min.). A "ground" on the Event Warning Line will generate an "ON" in the MUX-8A transmitted record and the Storage Interval will be one minute. A transition from "open" to "ground" will generate an "(OFF)" and a transition from "ground" to "open" will generate an "(ON)" in the MUX-8A transmitted record. Also, data will be stored in memory at each transition.

Control Switch:

This switch allows you to set the MUX-8A to "BURST" (store data continuously), "ON" (store data at the Storage Interval) or "Download" (downloads data to a P.C.).

Record Light:

When the MUX-8A is storing data, the Record Light will be on.

RS-232 Output:

Outputs RS-232 data at 9600 baud, 8 data bits, 1 start bit (logic high) and 1 stop bit (logic low). All logic levels meet the EIA RS-232 specifications. Data is in a comma delimited format and is terminated with a carriage return (0Dh) line feed (0Ah) at the end of each record.

RS-232 (5V) Output:

Outputs RS-232 (5V) data at 9600 baud, 8 data bits, 1 start bit (logic low) and 1 stop bit (logic high 5-volts). Data is in a comma delimited format and is terminated with a carriage return (0Dh) line feed (0Ah).

MUX-8A Wiring Diagram

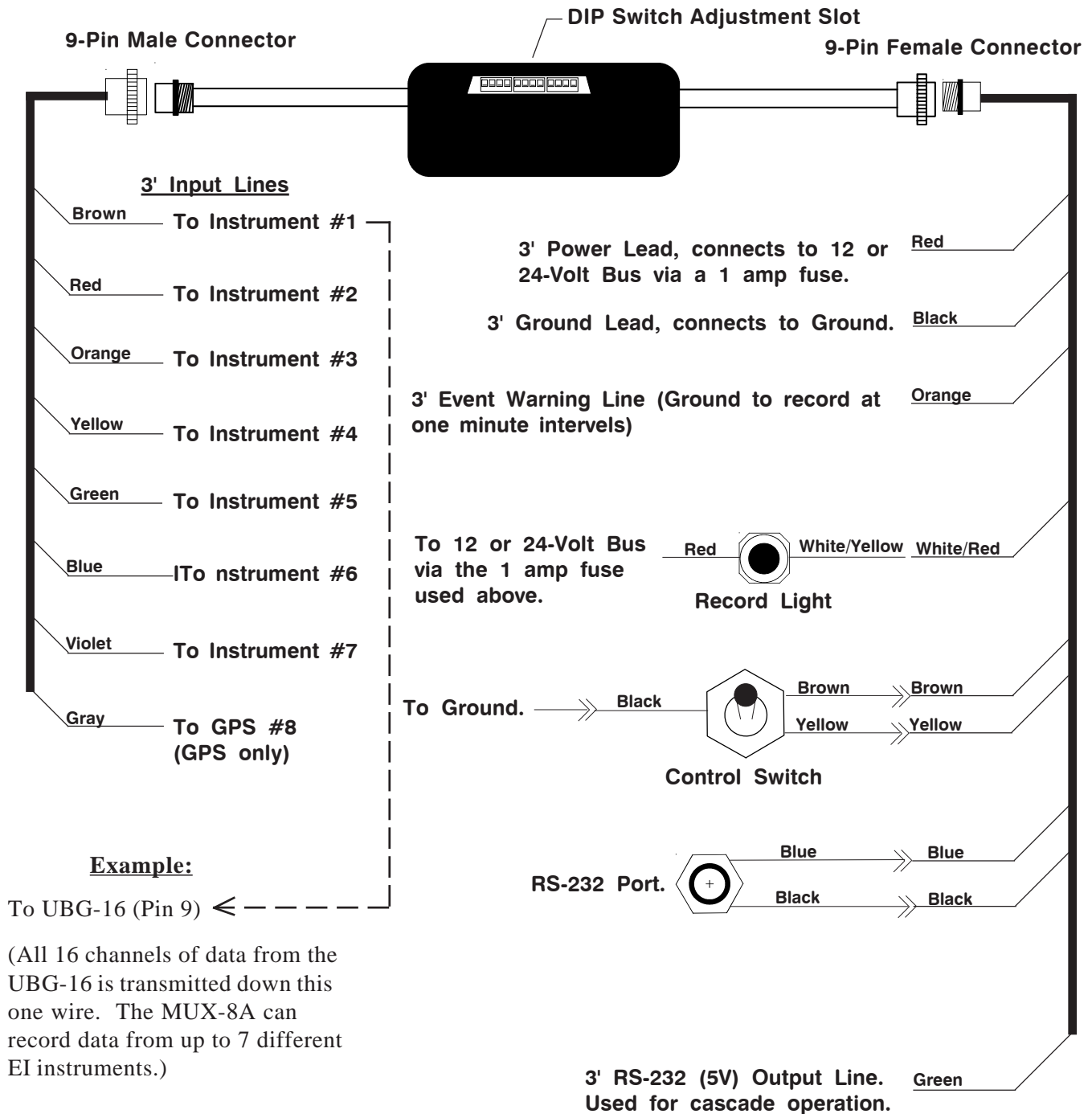

(All 16 channels of data from the UBG-16 is transmitted down this one wire. The MUX-8A can record data from up to 7 different EI instruments.)

UBG-16

RS-232 (5-volt) Output

12/21/99

1. General Description:

The UBG-16 transmits serial RS-232 (5-volt) data on the white/green wire (pin 9). The serial data transmitted is the same as that shown on the digital display as each channel is selected. The white/green wire may be connected to a PC through Electronics International's Data Recorder (MUX-8A). If the transmitted signal is inverted, it may be connected directly to a PC. The serial data is transmitted in a comma delimited format, suitable for importing into most spreadsheet and data base programs.

2. Instrument Operation:

The RS-232 (5-volt) output does not affect the operation of the R-1.

3. Transmit Specifications:

- * Baud Rate: 9600
- * Data Bits: 8
- * Start Bit: 1 (Logic Low)
- * Stop Bit: 1 (Logic High 5-volts)
- * Parity: None
- * Transmit Rate: 5 seconds

4. Transmit Format:

The UBG-16 transmits the following record:

UBG,L1,R1,L2,R2,L3,R3,L4,R4,L5,R5,L6,R6,L7,R7,L8,R8CrLf

- UBG Instrument identifier.
- ,
- L1 Left channel 1 reading (-999 to 1999 'F). Other left channels are L2, L3, etc.
- R1 Right channel 1 reading (-999 to 1999 'F). Other right channels are R2, R3, etc.
- Cr Carriage return (0Dh)
- Lf Line feed (0Ah)

5. Hook-Up:

The white/green wire connected to pin 9 transmits RS-232 (5-volt) serial data.

GPS

RS-232 Data Sheet

12/21/99

If channel 8 on the MUX-8A is connected to the RS-232 moving map output from a GPS unit, the following data will be transmitted each time channel 8 is scanned:

GPS,A,B,C,D,K,CrLf

- GPS Instrument identifier.
- ,
- A Present Latitude = s dd mmhh
s = sign "N" for north, "S" for south
dd = degrees
mm = minutes
hh = hundredths of minutes
- B Present Longitude = s dd mmhh
s = sign "N" for north and "S" for south
dd = degrees
mm = minutes
hh = hundredths of minutes
- C Magnetic Track = ddd = degrees
- D Ground Speed = ddd = knots
- K Active waypoint identifier = ddd(dd)
- Cr Carriage return (0Dh)
- Lf Line feed (0Ah)

R-1

RS-232 (5-volt) Option

0115981

1/15/98

1. General Description:

This option transmits serial RS-232 (5-volt) data on the white/green wire (pin 9) of the R-1. The serial data transmitted is the same as that shown on the digital display of the R-1. The white/green wire may be connected to a PC through Electronics International's 8 Channel Multiplexer Unit (MUX-8). If the transmitted signal is inverted, it may be connected directly to a PC. The serial data is transmitted in a comma delimited format, suitable for importing into most spreadsheet and data base programs.

2. Instrument Operation:

The RS-232 (5-volt) option does not affect the operation of the R-1. See the R-1 Operating and Installation Instructions for R-1 operating information.

3. Transmit Specifications:

- * Baud Rate: 9600
- * Data Bits: 8
- * Start Bit: 1 (Logic Low)
- * Stop Bit: 1 (Logic High 5-volts)
- * Parity: None
- * Transmit Rate: 1/3 sec.

4. Transmit Format: The R-1 transmits the following record:

RPM,nnn0CrLf

RPM	Instrument identifier.
,	A comma separates data fields.
nnn0	Data as shown on the digital display (0000 to 9990). 10 count resolution. Reading below 300 read 0000.
Cr	Carriage return (0Dh)
Lf	Line feed (0Ah)

5. Hook-Up:

Place the white/green wire (included in the kit) into pin 9 from the back of the R-1 cable harness. RS-232 (5-volt) serial data is transmitted on this wire.

M-1

RS-232 (5-volt) Option

0114981

1/14/98

1. General Description:

This option transmits serial RS-232 (5-volt) data on the white/green wire (pin 9) of the M-1. The serial data transmitted is the same as that shown on the digital display of the M-1. The white/green wire may be connected to a PC through Electronics International's 8 Channel Multiplexer Unit (MUX-8). If the transmitted signal is inverted, it may be connected directly to a PC. The serial data is transmitted in a comma delimited format, suitable for importing into most spreadsheet and data base programs.

2. Instrument Operation:

The RS-232 (5-volt) option does not affect the operation of the M-1. See the M-1 Operating and Installation Instructions for M-1 operating information.

3. Transmit Specifications:

- * Baud Rate: 9600
- * Data Bits: 8
- * Start Bit: 1 (Logic Low)
- * Stop Bit: 1 (Logic High 5-volts)
- * Parity: None
- * Transmit Rate: 1/3 sec.

4. Transmit Format: The M-1 transmits the following record:

MP,nn.nCrLf

- MP Instrument identifier.
- ,
- nn.n Data as shown on the digital display (00.0 to 99.9). Positive numbers only.
- Cr Carriage return (0Dh)
- Lf Line feed (0Ah)

5. Hook-Up:

Place the white/green wire (included in the kit) into pin 9 from the back of the M-1 cable harness. RS-232 (5-volt) serial data is transmitted on this wire.

OPT-1

RS-232 (5-volt) Option

0115982

1/15/98

1. General Description:

This option transmits serial RS-232 (5-volt) data on the white/green wire (pin 7) of the OPT-1. The serial data transmitted is the same as that shown on the digital display when displaying temperature and pressure. The white/green wire may be connected to a PC through Electronics International's 8 Channel Multiplexer Unit (MUX-8). If the transmitted signal is inverted, it may be connected directly to a PC. The serial data is transmitted in a comma delimited format, suitable for importing into most spreadsheet and data base programs.

2. Instrument Operation:

The RS-232 (5-volt) option does not affect the operation of the OPT-1. See the OPT-1 Operating and Installation Instructions for OPT-1 operating information.

3. Transmit Specifications:

- * Baud Rate: 9600
- * Data Bits: 8
- * Start Bit: 1 (Logic Low)
- * Stop Bit: 1 (Logic High 5-volts)
- * Parity: None
- * Transmit Rate: 1/4 sec.

4. Transmit Format: The OPT-1 transmits the following record:

OPT,LLLL,RRRR,CrLf

- OPT Instrument identifier.
- ,
- LLLL Left Channel Data as shown on the digital display (0000 to 1999).
Input signals below 5 read 0000.
- RRRR Right Channel Data as shown on the digital display (0000 to 1999).
- Cr Carriage return (0Dh)
- Lf Line feed (0Ah)

5. Hook-Up:

Place the white/green wire (included in the kit) into pin 7 from the back of the OPT-1 cable harness. RS-232 (5-volt) serial data is transmitted on this wire.

FP-5L

RS-232 (5-volt) Option

1014031

10/14/03

1. General Description:

The RS-232 (5-volt) option transmits serial RS-232 (5-volt) data on the white/green wire (pin 15) of the FP-5L. The serial data transmitted is the same as that shown on the digital display when displaying Fuel Flow (in gal/hr), Fuel Remaining (in gal/hr) and the AUX channel. The transmitted format is compatible with the MUX-8A and if the transmitted signal is inverted, it may be connected directly to a P.C. The serial data is transmitted in a comma delimited format, suitable for importing into most spreadsheet and data base programs. The transmitted format for this RS-232 Option is not compatible with GPS units. The received format was not changed and is compatible with GPS units.

2. Instrument Operation:

Although the RS-232 (5-volt) option does not affect the operation of the FP-5L, the operation of the FP-5L can affect the transmission rate. If the FP-5L is place in any programming mode the transmission of data will stop until the FP-5L is returned to normal operation. Also, the "GPS Receive Format" and the "Display Update Time" will affect the Baud Rate or Transmit Rate (see Power-up Programming). But, the "GPS Transmit Format" setting has no effect on the RS-232 (5-volt) output.

3. Transmit Specifications:

- * Baud Rate: 9600 baud when "GPS Receive Format" is set to "In1" (see Power-up Programming).
 (9600 is the only baud rate that will interface with the MUX-8A)
 1200 baud when "GPS Receive Format" is set to "In2" (see Power-up Programming).
 4800 baud when "GPS Receive Format" is set to "In3" (see Power-up Programming).
- * Data Bits: 8
- * Start Bit: 1 (Logic Low)
- * Stop Bit: 1 (Logic High 5-volts)
- * Parity: None
- * Transmit Rate: 1.5 sec. for "Display Update Time" set to "UP1" (see Power-up Programming).
 0.5 sec. for "Display Update Time" set to "UP2" (see Power-up Programming).

4. Transmit Format: The FP-5L transmits the following record:

FP,FFF.F,RRR.R,AAAACrLf

FP	Instrument identifier.
,	A comma separates data fields.
FFF.F	Fuel Flow in gal/hr.
RRR.R	Fuel Remaining in gal/hr.
AAAA	AUX Channel Data
Cr	Carriage return (0Dh)
Lf	Line feed (0Ah)

5. Hook-Up:

The white/green wire originally used to upload data to a GPS is now used to output data to the MUX-8A or to a PC via the MUX-8A. Set the "GPS Receive Format" to "In3" (9600 baud) on the FP-5L to interface with the MUX-8A.

ASC-5A

RS-232 (5-volt) Option

0116981

1/16/98

1. General Description:

This option transmits serial RS-232 (5-volt) data on the white/green wire (pin 16) of the ASC-5A. The serial data transmitted is the same as that shown on the digital display when displaying Barometric Pressure, Encoder Altitude, OAT and Zulu Time. The white/green wire may be connected to a PC through Electronics International's 8 Channel Multiplexer Unit (MUX-8). If the transmitted signal is inverted, it may be connected directly to a PC. The serial data is transmitted in a comma delimited format, suitable for importing into most spreadsheet and data base programs.

2. Instrument Operation:

Although the RS-232 (5-volt) option does not affect the operation of the ASC-5A, the operation of the ASC-5A can affect the transmission rate. If the ASC-5A is placed in any programming mode, the transmission of data will stop until the ASC-5A is returned to normal operation.

3. Transmit Specifications:

- * Baud Rate: 9600
- * Data Bits: 8
- * Start Bit: 1 (Logic Low)
- * Stop Bit: 1 (Logic High 5-volts)
- * Parity: None
- * Transmit Rate: 1/3 sec.

4. Transmit Format: The ASC-5A transmits the following record:

ASC,ZZ:ZZ,BB.BB,AAA00,TTTTCrLf

ASC	Instrument identifier.
,	A comma separates data fields.
ZZ:ZZ	Zulu Time in hours and minutes (NOTE: Zulu Time is NOT stored in the MUX).
BB.BB	Barometric Pressure ("Hg) as set by the pilot.
AAA00	Encoder Altitude (100 feet resolution). If Data is not valid, "OFF" will be transmitted.
TTTT	OAT (-999 to 999 'F)
Cr	Carriage return (0Dh)
Lf	Line feed (0Ah)

5. Hook-Up:

Place the white/green wire (included in the kit) into pin 16 from the back of the ASC-5A cable harness. RS-232 (5-volt) serial data is transmitted on this wire.

US-8A

RS-232 (5-volt) Option

0116983

1/16/98

1. General Description:

This option transmits serial RS-232 (5-volt) data on the white/green wire (pin 9) of the US-8A. The serial data transmitted is the same as that shown on the digital display as each channel is selected (in the "Scan" mode only). The white/green wire may be connected to a PC through Electronics International's 8 Channel Multiplexer Unit (MUX-8). If the transmitted signal is inverted, it may be connected directly to a PC. The serial data is transmitted in a comma delimited format, suitable for importing into most spreadsheet and data base programs.

2. Instrument Operation:

Normally the "Scan Rate" on the US-8A can be set between 2 and 9 seconds. The RS-232 (5-volt) option allows the Scan Rate to be set between 0 and 9 seconds. For a given Scan Rate the US-8A operates as follows:

- 0 Scan Rate: All the limits are disabled, the US-8A continuously scans regardless of the position of the Mode Selector Switch and the US-8A will scan 8 channels in 5 seconds. A 0 Scan Rate setting allows the US-8A to transmit serial data at all times.
- 1 Scan Rate: All the limits are disabled, and the US-8A will scan 8 channels in 5 seconds. A 1 Scan Rate setting allows the US-8A to transmit serial data as long as the unit is in the Scan operating mode.
- 2 to 9 Scan Rate: The US-8A operates normally. If the US-8A scan is stopped for any reason, the transmission of data will stop.

For all Scan Rate settings, the US-8A will transmit data only for the channels scanned.

3. Transmit Specifications:

- * Baud Rate: 9600
- * Data Bits: 8
- * Start Bit: 1 (Logic Low)
- * Stop Bit: 1 (Logic High 5-volts)
- * Parity: None
- * Transmit Rate: 5 seconds for a Scan Rate of 0 or 1.

4. Transmit Format:

The US-8A transmits the following record when the "Last Channel" is set to 8:

US,L1,R1,L2,R2,L3,R3,L4,R4,L5,R5,L6,R6,L7,R7,L8,R8CrLf

US	Instrument identifier.
,	A comma separates data fields.
L1	Left channel 1 reading (-999 to 1999 'F). Other left channels are L2, L3, etc.
R1	Right channel 1 reading (-999 to 1999 'F). Other right channels are R2, R3, etc.
Cr	Carriage return (0Dh)
Lf	Line feed (0Ah)

5. Hook-Up:

Place the white/green wire (included in the kit) into pin 9 from the back of the US-8A cable harness. RS-232 (5-volt) serial data is transmitted on this wire.