

Fuel Flow/Pressure

(FP-5 and FP-5L)

Installation Instructions

II 0506931

5/6/93
Rev. I: 7/2/02

You must read this manual before installing or operating the instrument. This manual contains warranty and other information that may affect your decision to install this product and/or the safety of your aircraft.

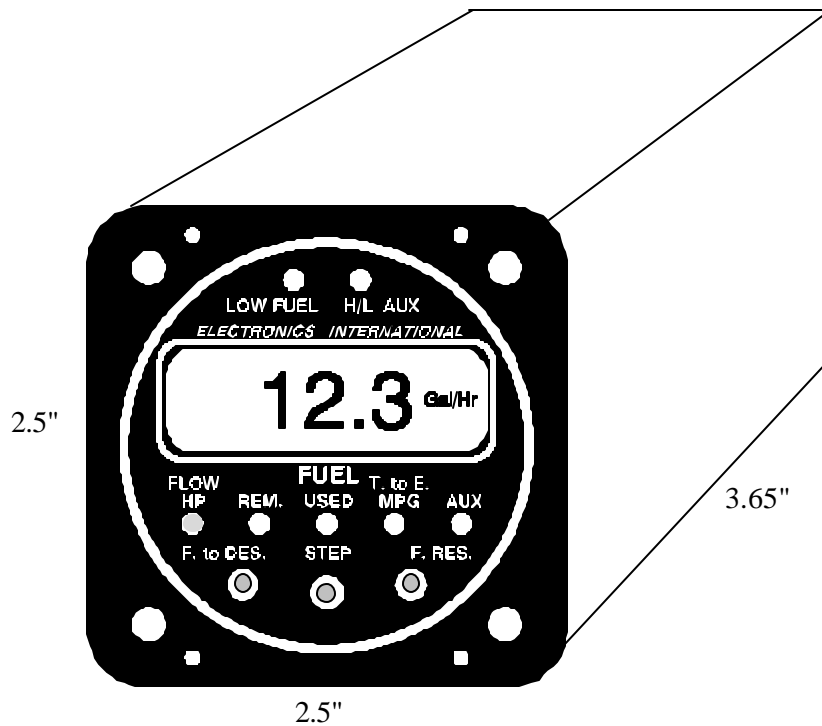

Unit Model: _____ S/N: _____

Flow Transducer Model: _____ S/N: _____



Electronics International Inc. ®

63296 Powell Butte Hwy • Bend, OR 97701 • (541) 318-6060 • www.Buy-El.com 

Important Notice

***** MUST READ *****

If you think it is not important to read this manual, you're wrong! This manual contains important installation information that may affect the safety of your aircraft, delay your installation or affect the operation of your instrument. You Must read this manual prior to installing your instrument. Any deviation from these installation instructions is the sole responsibility of the installer/pilot and may render the STC invalid.

Read the Warranty / Agreement. There is information in the Warranty / Agreement that may alter your decision to install this product. **If you do not accept the terms of the Warranty / Agreement, do not install this product.** This product may be returned for a refund. Contact Electronics International inc. for details.

A gravity feed fuel system or any engine rated over 300 H.P. *must* use an FT-90 flow transducer. An engine rated over 550 H.P. *must* use the FT-180 flow transducer. The standard Fuel Transducer (FT-60) shipped with the FP-5 or FP-5L Fuel Flow/Pressure instrument is intended to be used on aircraft equipped with fuel pumps with engines rated below 300 H.P.

Transducer Identification Markings: There are two suppliers of the FT-60 and FT-90 Flow Transducer (E.I. inc and Flowscan). The E.I. units are equipped with a PMA label.

FT-60 - The Flowscan unit is marked "201" on the top of the unit.

FT-90 - The Flowscan unit is marked "231" on the top of the unit.

FT-180 - Equipped with a 3/4 - 16 male fitting.

On a gravity feed system the fuel pressures are lower than the FP-5 or FP-5L can measure. Therefore, disable the Fuel Pressure feature on the FP-5 or FP-5L when used on a gravity feed system.

If your aircraft is not covered on our STC (found at the back of this manual), **you must perform the flow and pressure tests in FAA document A.C. 23.955-1 (Substantiating Flow Rates and Pressures in Fuel Systems of Small Airplanes) to insure safe and proper operation.**

Installation of the FP-5 on an aircraft with a fuel return line from the Pressure Carburetor requires a FFDM-1 Differential Module (see price sheet).

The placard "Do Not Rely on Fuel Flow Instrument to Determine Fuel Levels in Tanks" must be mounted on the aircraft instrument panel near the FP-5.

If the aircraft is equipped with a primary fuel flow and/or pressure instrument, the following placard must be mounted on the aircraft instrument panel near the FP-5: "Refer to Original Fuel Flow/ Pressure Instrumentation for Primary Information".

Contents

Warranty	2
1. Important Information and Initial Check Out:	3
2. Install the Fuel Flow Transducer:	4
3. Install A Functional Module:	5
4. Install the Circular Connector:	5
5. Route the Power and Ground Wires:	6
6. Route the Backlight Wires:	6
7. Route the (Optional) External Warning Control Line:	6
8. Route the Fuel Flow Transducer Wires:	6
9. Install A Functional Module:	7
10. (FP-5L Only) Connect the RS-232/422 Input Lines:	7
11. (FP-5L Only) Connect the RS-232 Output Line:	8
12. Install the Fuel Flow Differential Module (FFDM-1)	8
13. Install the Instrument in the Panel:	9
14. Connect the Circular Connector to the Instrument:	9
15. System Check-out:	9
16. Initial Programming:	10
Wiring Diagrams	11
Circular Connectors	13
Specifications and Operating Features	15
Fuel Flow Transducer Installation Drawings:	17-20
STC Information	Appendix

Warranty / Agreement

Electronics International Inc. (E.I. inc.) warrants this instrument and system components to be free from defects in materials and workmanship for a period of one year from the user invoice date. **Fuel Flow and Pressure Transducers are NOT covered under this warranty.** They are covered by the original equipment manufacturer. Electronics International Inc. will repair or replace any item, at its sole discretion, covered under the terms of this Warranty provided the item is returned to the factory prepaid.

1. This Warranty shall not apply to any product that has been repaired or altered by any person other than Electronics International Inc., or that has been subjected to misuse, accident, incorrect wiring, negligence, improper or unprofessional assembly or improper installation by any person. **This warranty does not cover any reimbursement for any person's time for installation, removal, assembly or repair.** Electronics International retains the right to determine the reason or cause for warranty repair.
2. This Warranty does not extend to any machine, vehicle, boat, aircraft or any other device to which the Electronics International Inc. product may be connected, attached, interconnected or used in conjunction with in any way.
3. The obligation assumed by Electronics International Inc. under this Warranty is limited to repair, replacement or refund of the product, at the sole discretion of Electronics International Inc.
4. Electronics International Inc. is not liable for expenses incurred by the customer or installer due to factory updates, modifications, improvements, upgrades, changes, or any other alterations to the product that may affect the form, fit, function or operation of the product.
5. Personal injury or property damage due to misinterpretation or lack of understanding of this product is solely the pilot's responsibility. The pilot **must** understand the operation of this product before flying the aircraft. Do not allow anyone to operate the aircraft that does not know the operation of this product. Keep the Operating Manual in the aircraft at all times.
6. E. I. Inc. is not responsible for shipping charges or damages incurred under this Warranty.
7. No representative is authorized to assume any other liability for Electronics International Inc. in connection with the sale of Electronics International Inc. products.
8. **If you do not agree to and accept the terms of this Warranty, you may return the product for a refund.**

This Warranty is made only to the original user. **THIS WARRANTY IS IN LIEU OF ALL OTHER WARRANTIES OR OBLIGATIONS: EXPRESS OR IMPLIED. MANUFACTURER EXPRESSLY DISCLAIMS ALL IMPLIED WARRANTIES OF MERCHANTABILITY OR FITNESS FOR A PARTICULAR PURPOSE. PURCHASER AGREES THAT IN NO EVENT SHALL MANUFACTURER BE LIABLE FOR SPECIAL, INCIDENTAL OR CONSEQUENTIAL DAMAGES, INCLUDING LOST PROFITS OR LOSS OF USE OR OTHER ECONOMIC LOSS. EXCEPT AS EXPRESSLY PROVIDED HEREIN, MANUFACTURER DISCLAIMS ALL OTHER LIABILITY TO PURCHASER OR ANY OTHER PERSON IN CONNECTION WITH THE USE OR PERFORMANCE OF MANUFACTURER'S PRODUCTS, INCLUDING SPECIFICALLY LIABILITY IN TORT.**

FP-5 and FP-5L

Installation Instructions

1. Important Information and Initial Check Out:

- A. **The installer and aircraft owner must read the Warranty before starting the installation.** There is information in the Warranty that may alter your decision to install this instrument. **If you do not accept the terms of the Warranty, do not install this instrument.**
- B. **If you are not an FAA Certified Aircraft Mechanic familiar with the issues of installing aircraft fuel flow and pressure instruments, Do Not attempt to install this instrument.** The installer should use current aircraft standards and practices to install this instrument (refer to AC 43.13).
- C. **Check that any necessary FAA Approvals (STCs, etc.) are available for your aircraft before starting the installation. The FAA Approved Model List (AML) is located at the back of this manual. Resolve any issues you may have before starting the installation.**
- D. Before starting installation, read the entire Installation Instructions and resolve any installation, operating and performance issues you may have before starting the installation.
- E. **THIS INSTALLATION WILL REQUIRE SOME PARTS UNIQUE TO YOUR AIRCRAFT THAT ARE NOT SUPPLIED IN THE KIT (including, but not limited to hoses and fittings).** Acquire all the parts necessary to install this instrument before starting the installation.
- F. Check that the instrument and flow transducer make and model are correct before starting the installation (check your invoice and the markings on the side of the instrument). **A gravity feed fuel system or any engine rated over 300 H.P. must use an FT-90 flow transducer.** A pressure carbureted engine with a fuel return line requires an FFDM-1 (see price sheet).

Transducer Identification Markings: There are two suppliers of the FT-60 and FT-90 Flow Transducer (E.I. inc and Flowscan). The E.I. units are equipped with a PMA label.

FT-60 - The Flowscan unit is marked "201" on the top of the unit.

FT-90 - The Flowscan unit is marked "231" on the top of the unit.

FT-180 - Equipped with a 3/4 - 16 male fitting.

- G. Before starting the installation make sure the unit will fit in the location you intend to install it without obstructing the operation of any controls.
- H. If this instrument is to replace an existing unit in the aircraft, it is the installer's responsibility to move or replace any existing instruments or components in accordance with FAA approved methods and procedures. The following Installation Instructions do not cover moving or the removal of any existing instruments or components.

2. Install the Fuel Flow Transducer:

Mount the Fuel Flow Transducer using the appropriate drawing at the back of this manual.

<i>Aircraft Configuration</i>	<i>Drawing #</i>	<i>Page</i>
Fuel injected engine without a fuel return line from the fuel servo (most Lycomings).	1229932 or 1229931	18 or 17
Fuel injected engine with a fuel return line from the fuel servo (most Continentals).	0415941	20
Carbureted engine with a fuel pump and no fuel return line.	1229932 or 1229931	18 or 17
Carbureted engine with a fuel pump and a fuel return line (requires an FFDM-1 Module).	1229932 or 1229931, and 1015941	18 or 17, and 19
Carbureted engine with a gravity feed fuel system (requires an FT-90 Flow Transducer).	1229932 or 1229931	18 or 17

The instructions listed below must be followed when installing a Fuel Flow Transducer.

Note: If your engine is equipped with a Pressure Carburetor with a fuel return line from the carburetor back to the fuel tank, you will need to install two flow transducers: one in the feed line from the fuel pump to the carburetor and one in the return line from the carburetor back to the fuel tank. Also, a Fuel Flow Differential Module (FFDM-1) will need to be installed. See drawings 1229932 and 1015941 at the back of this manual.

A. The transducer output port should be mounted lower, even or no more than 4" per foot higher than the carburetor inlet port (or fuel servo on a fuel injected engine). If this is not possible, a loop should be put in the fuel line between the Fuel Flow Transducer and the carburetor or fuel servo (see diagram below).

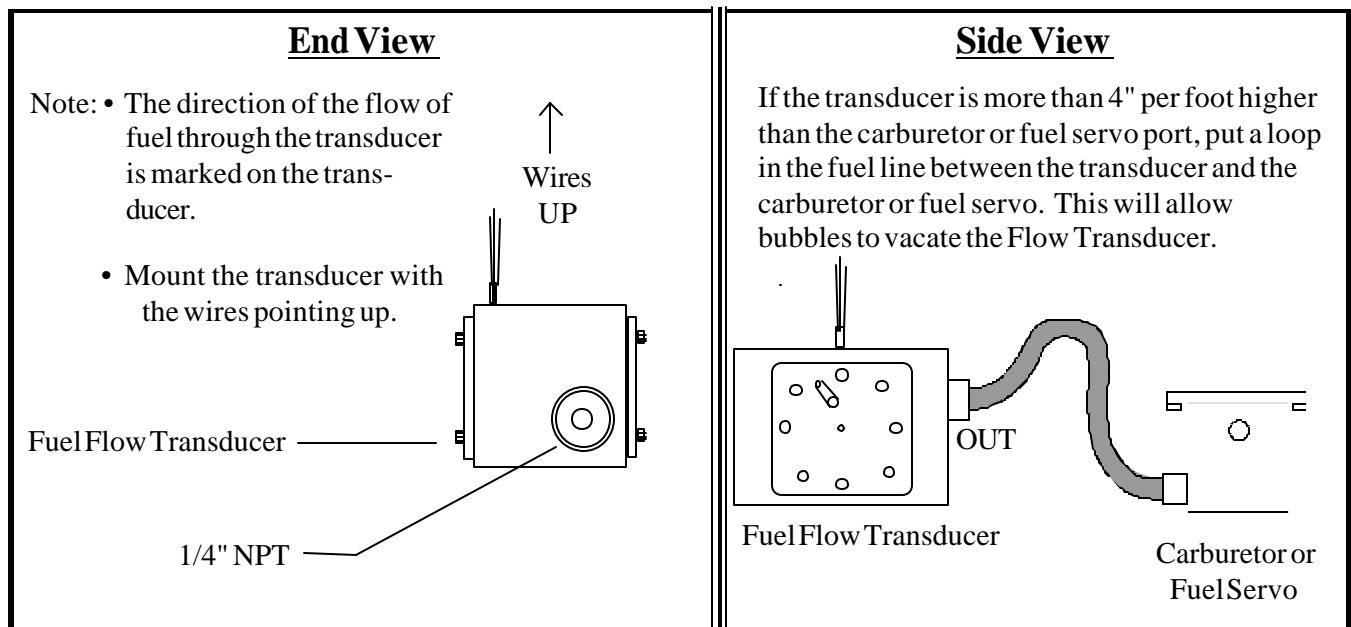

B. Do not remove the caps on the flow transducer until the fuel hoses are ready to be installed.

C. The flow of fuel through the transducer must follow the direction marked on the transducer.

- D. The flow transducer must be mounted so the wires exiting the transducer are pointing up.
- E. Before connecting any hoses, thoroughly clean them and insure they are free of any loose material. High air pressure may be used, **however, do not allow high air pressure to pass through the flow transducer.**
- F. When mounting a Fuel Flow Transducer make provisions for the Fuel Pressure Transducer as necessary.

You may want to consider using some Fittings and Hoses shown below. Note: **DO NOT EXCEED a torque of 15 ft. lbs. or screw the fittings tighter than two full turns past hand tight, whichever happens first.**

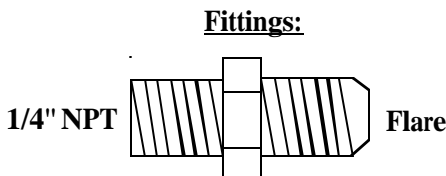

- #4 Straight - AN816-4-4D
- #6 Straight - AN816-6D
- #8 Straight - AN816-7D

- #6 45' - MS20823-6D
- #4 90' - MS20822-4-4D
- #6 90' - MS20822-6D

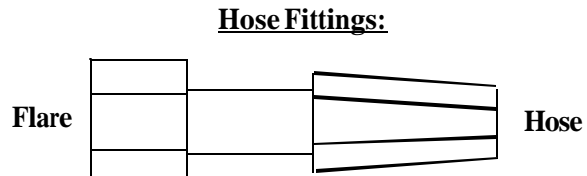

- Stright - MS24587-XX, Stratoflex 300-, Aeroquip 400-45' - MS27226-XX, Stratoflex 646- and 640, Aeroquip 980006
 - 90' - MS27224-XX, Stratoflex 649- and 643, Aeroquip 980005
- NOTE:** The Stratoflex teflon hose can be much more flexible and easier to route than most existing hoses. If you have a hard to fit installation, consider this hose.

3. Install A Functional Module:

A Functional Module is a small box with circuitry used to convert pressure, temperature, voltage, amps, etc. to an appropriate signal the FP-5(L) can display. This signal can be connected to the Aux Channel of the FP-5(L). These modules are small and light and are tie wrapped under the instrument panel. They come with a circular connector so they may be installed and removed easily.

Install any Functional Module at this time. Installation Instructions for the various Functional Modules come with the modules and are supplements to this installation manual.

4. Install the Circular Connector:

Starting from under the instrument panel, route the circular connector wire harness up to the instrument mounting location. (See the Wiring Diagram at the back of this manual). Place the circular connector about 8 inches back from the panel. Tie wrap the harness in place approximately 1 foot back from the circular connector. This will allow the harness to be flexible and accommodate varying lengths in instrument wires. **Be sure these wires do not obstruct the freedom of travel of any controls.**

5. Route the Power and Ground Wires:

In the wire harness are two sets of red and black 6' wire bundles used for the fuel pressure transducer and the fuel flow transducer. Also, there are red and black 3' wires used for instrument power and ground. Route the 3' red wire in the harness to the aircraft's 12 or 24 volt main or emergency bus as applicable via an independent circuit breaker (five amps or less). An alternate method would be to route the red lead to the bus via a one amp in-line fuse. **With this method a spare fuse must be kept in the aircraft.** Route the 3' black wire in the harness to a good ground. **Tie wrap these wires so they do not obstruct the freedom of travel of any controls.**

6. Route the Backlight Wires:

Connect the backlight wires as follows:

A. It is recommended to permanently power up the digital display backlight.

- 1) For a 12-volt system connect the white/brown wire to the bus and connect the white/red wire to ground (see Wiring Diagram).
- 2) For a 24-volt system leave the white/brown wire open and connect the white/red wire to the bus (see Wiring Diagram).

B. Connect the white/orange wire to the panel light rheostat. This wire will dim the Display Mode Indicator LEDs for night operation when the panel lights are turned on. If this line is left open, the Display Mode Indicator LEDs will remain at full intensity at all times. Also, if the voltage on this line drops below 11.5 volts, the analog LEDs will be displayed at full intensity. **Tie wrap all wires so they do not obstruct the freedom of travel of any controls.** Note: This line may be connected to the CP-1 Intensity Control Pot (see price sheet).

7. Route the (Optional) External Warning Control Line:

The white/yellow wire can be connected to E.I.'s external light (model AL-1), buzzer (model ATG-1), voice annunciator (model AV-17), a relay, etc. This wire grounds when the red warning light is on. The current in this line must be limited to 2/10 of an amp maximum. Exceeding this limit will damage the instrument. If this feature is not used, leave this line open. **Tie wrap this wire so it does not obstruct the freedom of travel of any controls.**

8. Route the Fuel Flow Transducer Wires:

The wire harness includes 6' red, black and white wires bundled together. Route and connect these 6' wires to the fuel flow transducer. If your engine is equipped with a fuel return line from the carburetor back to the fuel tank, route these wires to the Fuel Flow Differential Module (FFDM-1). See the appropriate drawing at the back of this manual.

Be sure the connectors mate properly. If the tab inside the male connector gets bent, it can wedge itself between the red nylon and metal female receptacle. This can result in an intermittent connection after about a month or more. If the connectors are disconnected several times the female connector can become loose. If this happens use a pair of needlenose pliers and tighten the metal receptacle inside the female connector.

Any excess wires can be rolled up and tie wrapped under the instrument panel. **Tie wrap these wires so they do not obstruct the freedom of travel of any controls.** If you decide to cut these wires to a specific length, strip each wire and double the wires over. An extra set of connectors is provided in the kit. Double crimp each connector. **Doubling the wires over and a good crimp are critical.**

Note: A dab or grease or two drops of oil on the red connectors will protect them for many years.

9. Install A Functional Module:

If the Aux channel on the FP-5 is to be used to monitor a function (EGT, TIT, Fuel Pressure, Oil Pressure, etc.) an appropriate Functional Module must be installed. A Functional Module is a small box with circuitry used to convert Temperature, Pressure, Voltage, Amps, etc. to an appropriate signal the FP-5 can display on the Aux channel. These modules are small and light and are tie wrapped under the instrument panel. They come with a Circular Connector so they may be installed and removed easily.

Install any Functional Modules at this time. Installation Instructions for the various Functional Modules come with the modules.

10. (FP-5L Only) Connect the RS-232/422 Input Lines:

Connecting the FP-5L Input Lines to a compatible GPS unit allows the FP-5L to display Fuel to Destination, Fuel Reserve, Nautical Miles per Gallon and Statute Miles per Gallon information. The FP-5L has three GPS Receive Formats: 1. "In1" for all panel mount GPS units (9600 baud); 2. "In2" for Northstar (1200 baud); 3. "In3" for hand held GPS units (NEMA at 4800 baud). The protocol is 1 start bit, 8 data bits and 1 stop bit and the RS-232 update time of the GPS unit should be 1 to 2 seconds. The GPS unit may require some setup. You may want to contact a knowledgeable instrument shop or the GPS factory to help with the hookup and setup of the GPS unit. See the "Power-Up Programmable Settings" section in the FP-5(L) Operating Instructions to configure the FP-5L RS-232 input.

<i>Type of Hook-up</i>	<i>FP-5L Connections</i>	<i>GPS Connections</i>
RS-232	RS-232 Input (white/blue wire)	RS-232 Output
RS-422 or RS-486	RS-232 Input (white/blue wire)	- Output
		+ Output (connect a 120 ohm resistor between the + Output and - Output)
Note: Do not connect any GPS shield wires to the FP-5L. They should be left open.		

11. (FP-5L Only) Connect the RS-232 Output Line:

Connecting the FP-5L Output Line to a compatible GPS unit allows the GPS unit to use the fuel data transmitted by the FP-5L. The FP-5L has three GPS Transmit Formats: 1. "Ot1" outputs older Shadin fuel flow data (for Arnav, King and newer Garmin GPS units); 2. "Ot2" outputs the Shadin fuel flow sentence (for Garmin and other GPS units); 3. "Ot3" outputs a modified Shadin Fuel/Airdata sentence (for UPS GPS units). The GPS unit may require some setup. You may want to contact a knowledgeable instrument shop or the GPS factory to help with the hookup and setup of the GPS unit. See the "Power-Up Programmable Settings" section in the FP-5(L) Operating Instructions to configure the FP-5L RS-232 output.

Connect the FP-5L RS-232 Output Line (White/Green Wire) to the GPS RS-232 Input Line. Do not connect any GPS shield wires to the FP-5L. They should be left open.

12. Install the Fuel Flow Differential Module (FFDM-1):

If your engine is equipped with a fuel return line from the carburetor back to the fuel tank, install the FFDM-1 in the aircraft as outlined below (see diagram at the back of this manual). Otherwise, omit this step.

- A. Connect the circular connector to the FFDM-1.
- B. Install the FFDM-1 under the instrument panel using two tie wraps on each end of the module to support it to a wire bundle or bracket.
- C. Route and connect the 3' red power lead to the 12 or 24 volt bus via a 1 amp fuse.
- D. Route and connect the 3' black ground lead to the same ground used for the FP-5.
- E. Route and connect the 6' red, black and white leads marked "Feed" to the flow transducer installed in the fuel line from the fuel pump to the carburetor.
- F. Route and connect the 6' red, black and white leads marked "Return" to the flow transducer installed in the return fuel line from the carburetor to the fuel tank.
- G. Connect the 1' red, black and white leads to the same color 6' leads from the FP-5.
- H. Be sure the connectors mate properly. If the tab inside the male connector gets bent, it can wedge itself between the red nylon and metal female receptacle. This can result in an intermittent connection after about a month or more. If the connectors are disconnected several times the female connector can become loose. If this happens use a pair of needlenose pliers and tighten the metal receptacle inside the female connector.

Any excess wires can be rolled up and tie wrapped under the instrument panel. **Tie wrap these wires so they do not obstruct the freedom of travel of any controls.** If you decide to cut these wires to a specific length, strip each wire and double the wires over. An extra set of connectors is provided in the kit. Double crimp each connector. **Doubling the wires over and a good crimp are critical.**

Note: The flow transducers for the FFDM-1 and the FP-5 **MUST** be of the same model (i.e., if the FP-5 uses an FT-60 flow transducer, then the FFDM-1 must use a FT-60 flow transducer).

Rev. I: 7/2/02

13. Install the Instrument in the Panel:

Install the instrument from behind the instrument panel using 6 x 32 screws. These screws must not be any longer than 1/2". Tie wrap any loose wires as needed. Make sure the instrument and wire do not obstruct the operation of any controls. **Mount the placard "Do Not Rely on Fuel Flow Instrument to Determine Fuel Levels in Tanks" on the aircraft instrument panel near the FP-5.**

If the aircraft is equipped with a primary fuel flow and/or pressure instrument, the following placard must be mounted on the aircraft instrument panel near the FP-5: "Refer to Original Fuel Flow/Pressure Instrumentation for Primary Information".

14. Connect the Circular Connector to the Instrument:

- A. Push the two mating connectors together and twist them until they snap into position.
- B. Turn the locking ring on the instrument connector clockwise (1 1/2 turns) until it locks into position.

15. System Check-out:

Check instrument operation as follows:

- A. Turn the aircraft master switch on (engine off) and verify that the red warning LED's on the FP-5 flash and the green "REM" mode LED is blinking. A problem at this step could be caused by poor connections on the red or black power and ground leads.
- B. Set the instrument toggle switch to "FLOW" and check for a digital fuel flow reading of "000." A problem at this step could be caused by a poor connection or crossed flow transducer wires. The voltage on the flow transducer wires (with the transducer removed from the instrument) should measure as follows:
 - Red Wire - +9 to 14 Volts
 - Black Wire - 0 Volts
 - White Wire - 0 or 5 Volts (plused when fuel is flowing)
- C. Check the digital display backlight. With high or medium ambient light it is hard to see the digital display backlight (it is only required during low ambient light conditions but should be on at all times).
- D. If the Display Mode Indicator LED dimming wire has been connected, turn the panel light rheostat up and look for the Display Mode Indicator LEDs to dim.
- E. With the engine running, check the "FLOW" Display Mode to read properly. If there is a problem at this point see step B above for troubleshooting information. To see if the instrument is receiving pulses from the flow transducer, disconnect the white wire from the transducer and short it rapidly (white wire to the instrument) to ground. A reading should appear on the display.

F. (FP-5L Only) Check the FP-5L display to read a number when the "F. to D." (Fuel to Destination) button is pushed. You may have to fly the aircraft before the GPS unit will output data. If the "F. to D." function is not working properly, use the following chart to help find your problem.

FP-5L Display	Comments
Off	The FP-5L is not receiving serial data. Check Connections and the setup of the Loran/GPS unit.
' on (note the bar)	The FP-5L is receiving serial data but it does not have the proper protocol. Check connections the Loran/GPS Interface settings on the FP-5L.
on	The FP-5L is receiving RS-232 data but the Speed and/or Distance data is missing. Check the setup of the Loran/GPS unit.

G. After running the engine, check the fuel hoses, transducers and fittings for leaks.

16. Initial Proramming:

The Power-Up Programmable Settings for the FP-5(L) must be set up for your aircraft. See the Power-Up Programmable Setting section in the Operating Instruction manual for set up information.

Fuel Flow/Pressure (FP-5 and FP-5L) Wiring Diagram

Do not use screws longer than 1/2" (4 ea.).

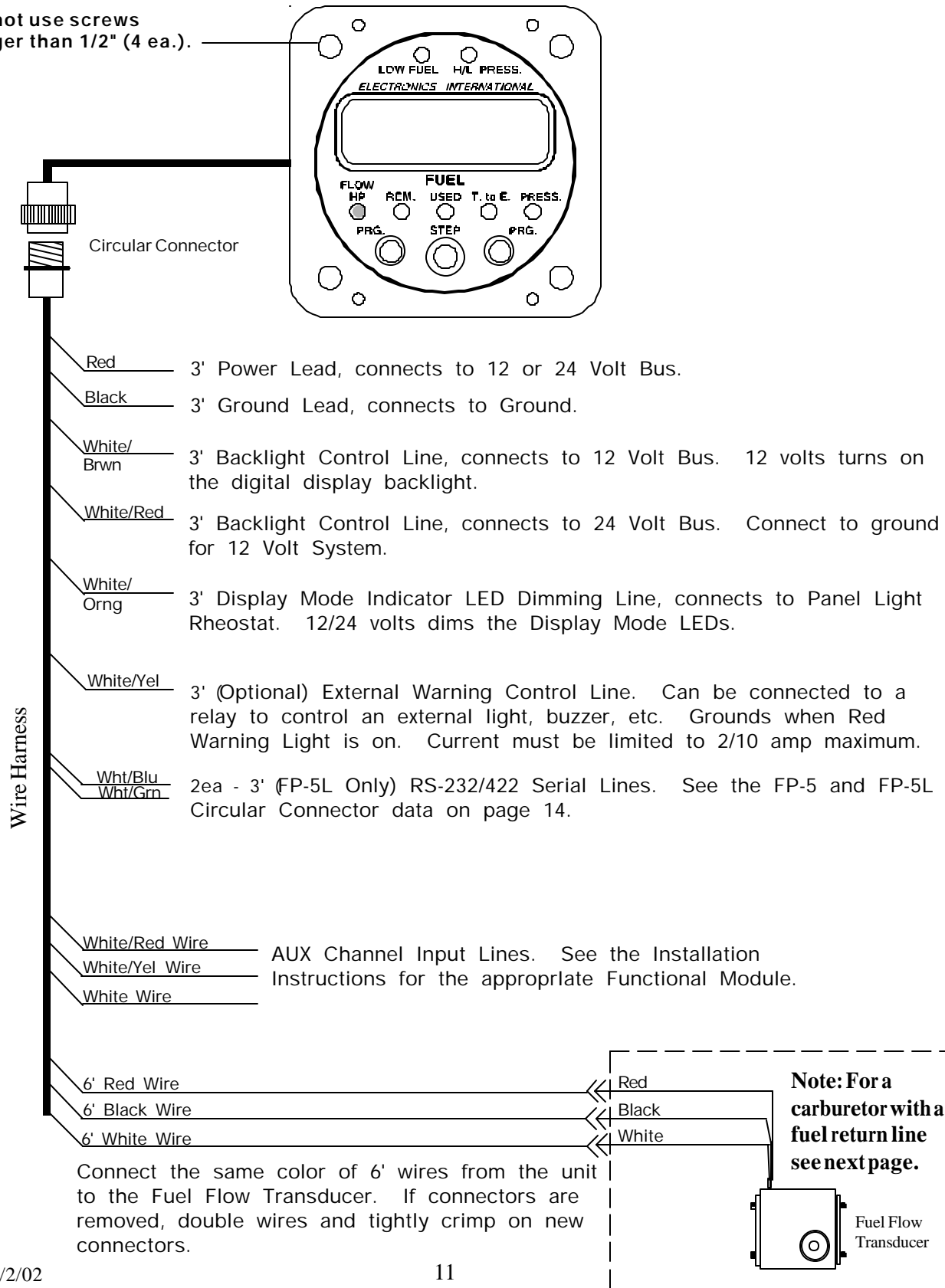

FP-5(L) / FFDM-1 Interconnect Wiring Diagram

WARNING!

Electronics International Inc. only authorizes the installation of the FFDM-1 with the FP-5 or FP-5L. Installing the FFDM-1 with any other manufacturer's instrument may seriously jeopardize the safety of the aircraft.

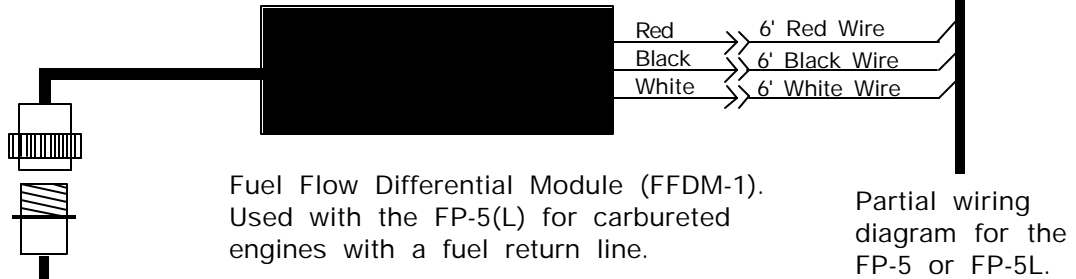
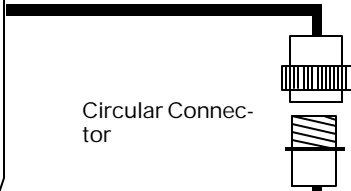
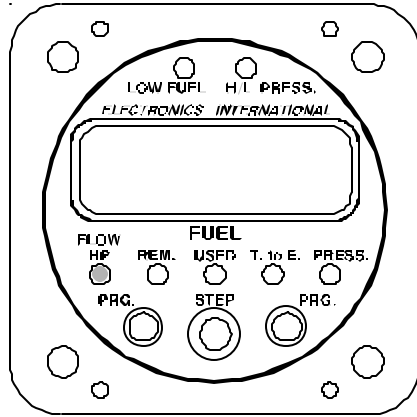

Circular Connector

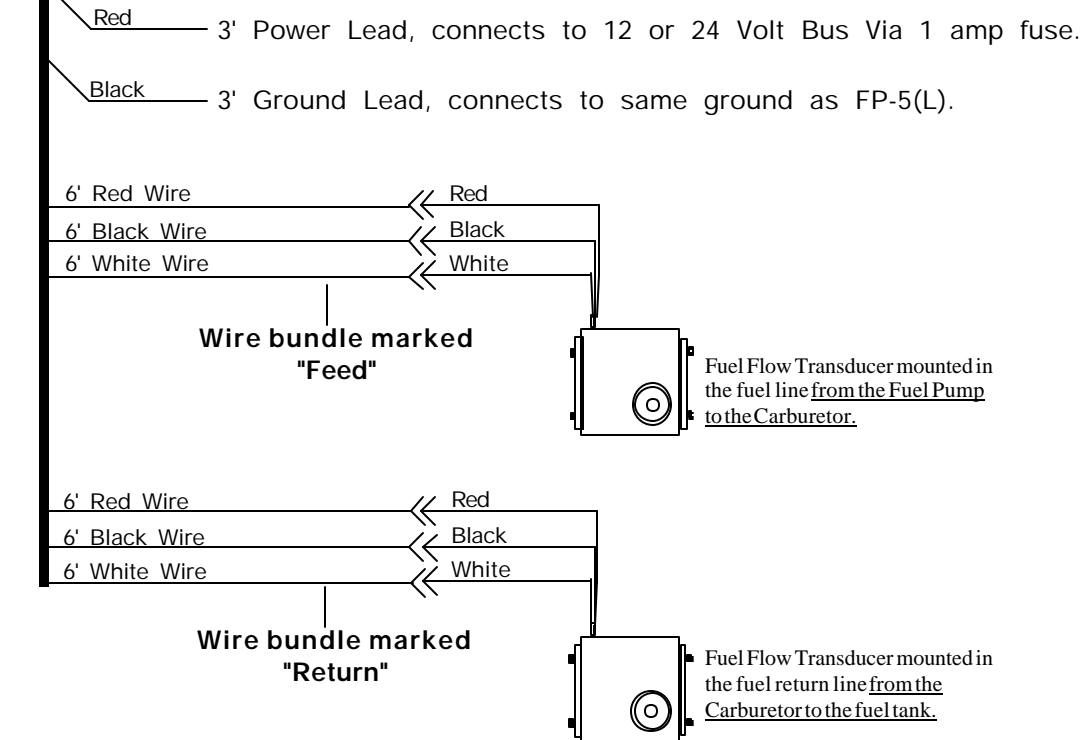

FP-5 and FP-5L Circular Connector

Connecting Cable Harness, Back View (wire side)
OR
Instrument Connector, Front View

Note: See Wiring Diagram for hookup information.

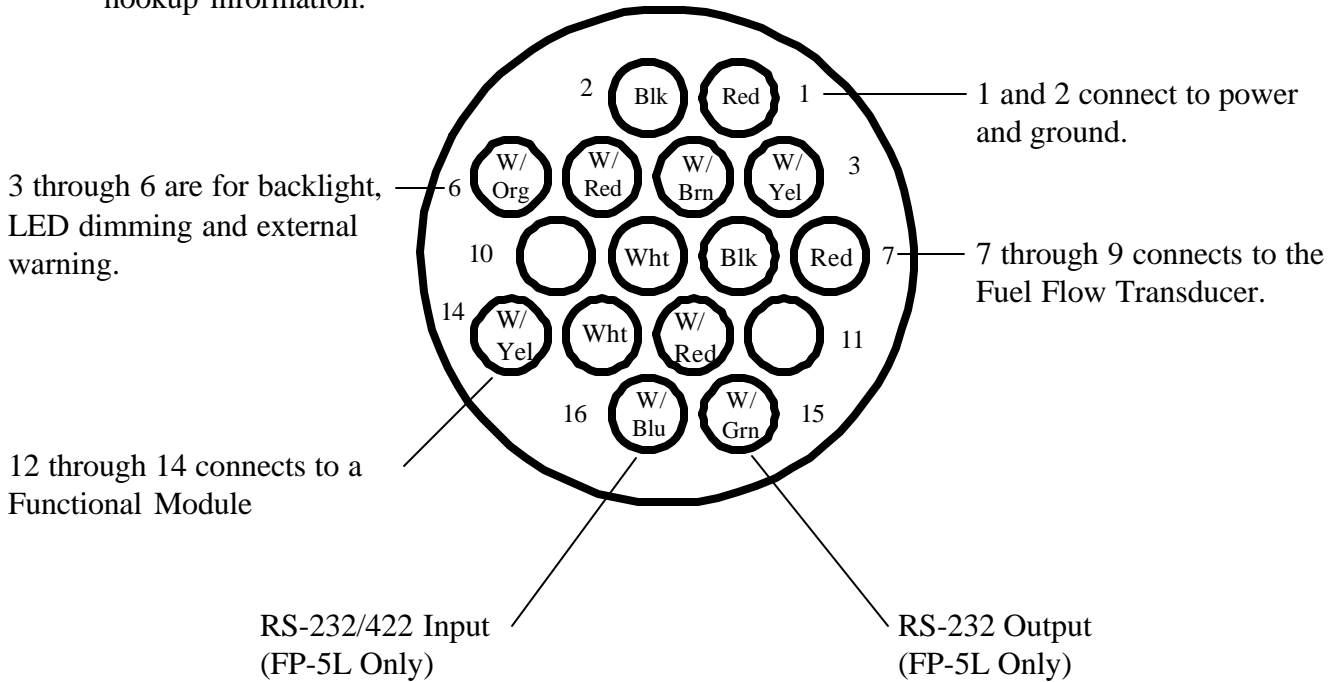

FFDM-1 Circular Connector

Connecting Cable Harness, Back View (wire side)

OR

Module Connector, Front View

Note: See Wiring Diagram
for hook up information.

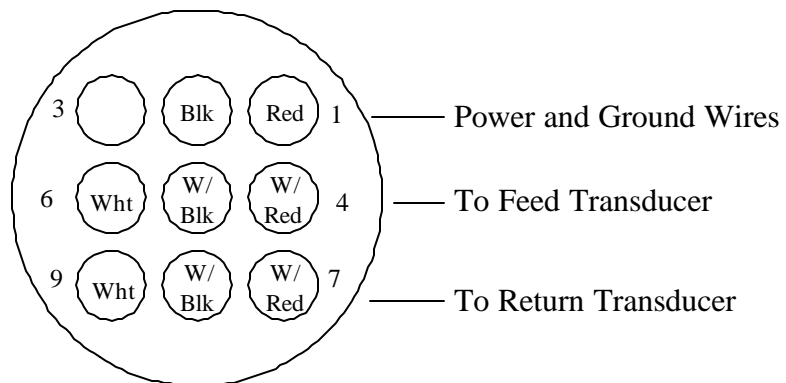

Specifications and Operating Features

Model:

FP-5 and FP-5L (Fuel Flow/Pressure Instrument)

Case Dimensions:

2.5" x 2.5" x 3.65" depth, 2 1/4" Bezel.

Weight:

Instrument Only:	11 Oz.
Flow Transducer FT-60 or FT-90:	6 Oz.

Environmental:

Meets TSO C44a/C47

Power Requirements:

7.5 to 35 Volts, 1/10 Amp.

Green Display Mode Indicator LEDs:

The intensity of these LEDs is controlled by the dimming wire. 12 or 24 volts on this wire will dim the LEDs for night operation.

Red Low Fuel Warning LED:

This LED will blink any time the programmed First or Second Low Fuel limit, Time to Empty Limit or Reoccurring Alarm is violated. The Low Fuel Warning LED is always displayed at full intensity and will flash on power-up.

Red H/L Fuel AUX Warning LED:

This LED will blink any time the programmed High or Low AUX limit is violated. The H/L AUX Warning LED is always displayed at full intensity and will flash on power-up.

Digital Display:

LCD (viewable in direct sunlight), with 12 and 24 volt backlight control wires for night operation. Displays "8888" on power up.

External Warning Control Line:

Grounds when any Red Warning LED is on or blinking. Current should be limited to 2/10 amp.

Accuracy:

Flow:	2% or better in accordance with TSO C44a.
Aux Channel:	2% in accordance with TSO.

Resolution:

Fuel Flow:	.1 Gal. or 1 Lb. or 1 Ltr.
Fuel Remaining:	.1 Gal. up to 99.9 Gal or 1 Lb. or 1 Ltr.
Fuel Used:	.1 Gal. up to 99.9 Gal or 1 Lb. or 1 Ltr.
Time to Empty:	1 minute
Aux:	1 or .1 (programmable).

Max Displayed Range (Unit Only):

Fuel Flow: 199.9 Gals/Hr or 162.0 br Gal/Hr or 1199 Lbs/Hr or 749 Ltr/Hr.
Fuel Remaining: 999 Gals. or 811 br Gal. or 1999 Lbs. or 1999 Ltr.
Fuel Used: 999 Gals. or 811 br Gal. or 1999 Lbs. or 1999 Ltr.
Time to Empty: 19 hours 59 minutes
AUX: +/- 1999

RS-232/422 Input Ports (FP-5L Only):

Single Line Receive Method: RS-232C or RS-423
Dual Line Receive Method: RS-422 or RS-485 (with 120 ohm external resistor)
Protocol: 1 Start bit, 8 Data bits, 1 Stop bit.
Baud Rate: 1200, 4800, 9600
Receive Format: Moving Map, Northstar or NEMA.

RS-232/422 Output Port (FP-5L Only):

Transmit Method: RS-232C Single Line.
Protocol: 1 Start bit, 8 Data bits, 1 Stop bit.
Baud Rate: 9600 (Receive Format must be set to Moving Map).
Transmit Format: King KLN88, Garmin, or UPS.

Fuel Flow Transducer, Standard (FT-60):

Range: 0.6 to 60 GPH
Linearity: 2% (8 to 60 GPH)
K Factor: Approx. 80,000
Pressure Drop: 1.2 PSI at 30 GPH
4.8 PSI at 60 GPH
Working Press: 200 PSI
Min. Burst Press: 2000 PSI
Temp. Range: -65°C to 125°C
Fuel Ports: 1/4" Female NPT

Fuel Flow Transducer, Special (FT-90):

Range: 3 to 90 GPH
K Factor: Approx. 19,500
Pressure Drop: .31 PSI at 30 GPH
2.8 PSI at 90 GPH
Working Press: 200 PSI
Min. Burst Press: 2000 PSI
Temp. Range: -65°C to 125°C
Fuel Ports: 1/4" Female NPT

Fuel Pressure Transducer (PT-100GA):

Range: 0 to 100 PSI
Over Press: 300 PSI without damage.
Min. Burst Press: 500 PSI
Temp. Range: -40°C to 125°C
Material: 303 Stainless Steel
Press. Port: 1/4" Male NPT

Fuel Flow Transducer, Special (FT-180):

Range: 3.6 to 180 GPH
K Factor: Approx. 48,000
Pressure Drop: 1.78 PSI at 120 GPH
Working Press: 3000 PSI
Temp. Range: -450°F to 300°F
Fuel Ports: 1/2" AN Male w/37' flare

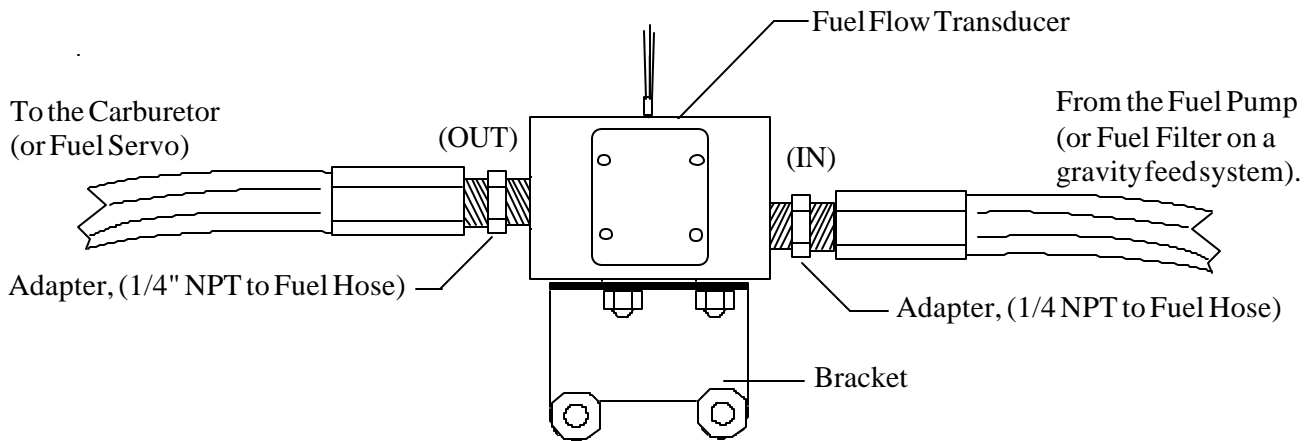

Mounting Procedure:

1. Find a convenient location on the fire wall (away from any hot exhaust pipes) and mount a bracket for the Fuel Flow Transducer. Check both sides of the fire wall for clearance before drilling any holes.
2. Mount the Fuel Flow Transducer onto the Bracket. **You must use the FT-90 Fuel Flow Transducer on a gravity feed system or for any engine over 300 H.P.** The FT-90 Transducer is marked "Model 231" on the top of the transducer. **If the Transducer is mounted within 6" of an exhaust pipe, the Flow Transducer must be wrapped with Fire Sleeving.**
3. Remove the fuel hose which goes from the Fuel Pump (or the Fuel Filter on a gravity feed system) to the Carburetor (or Fuel Servo).
4. Purchase two new hoses, one from the fuel pump (or the Fuel Filter) to the Fuel Flow Transducer (making provisions for the fuel pressure transducer as necessary) and the other from the Fuel Flow Transducer to the carburetor (or Fuel Servo). **There must be flexible hose in and out of the Transducer.** The hoses must meet TSO-C53a Type C or D FAA specification. **The new hoses must be the same size as the current hoses in the aircraft.** A source of fittings and fabricated hoses is:

Sacramento Sky Ranch Inc.
 (916) 421-7672
 Fax: (916) 421-5719

OR

Varga Enterprises Inc.
 (602) 963-6936
 FAX: (602) 899-0324

5. Read the Installation Instructions for important installation considerations.

Drawn By: R.R.	<i>Electronics International Inc.</i>		
Approved By: R.R.	Installation of a Fuel Flow Transducer on the Fire Wall and in the fuel line <u>from the fuel pump to the carburetor or fuel servo.</u>		
Scale: None	Note: <u>Not applicable</u> for a fuel injected engine with a fuel return line (see D/N 0415941).		
Material:			
Next Assembly:			
P/N:	Date: 12/29/93	Rev: D: 7/2/02	D/N: 1229931

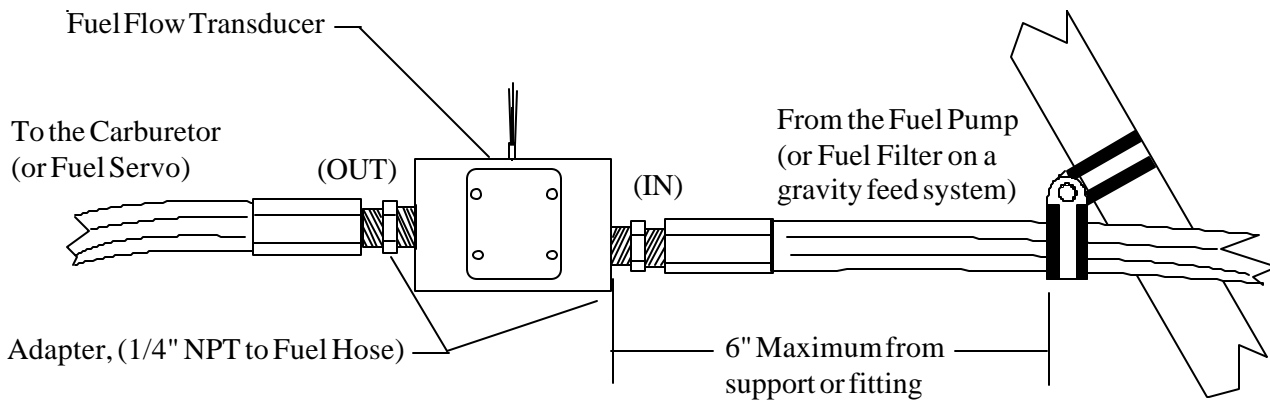

Mounting Procedure:

1. Find a convenient location within 6" of a hose support or fitting and away from any hot exhaust pipes to suspend the Fuel Flow Transducer. The hose support or fitting may be on the input or output line of the Flow Transducer.
2. Remove the fuel hose which goes from the Fuel Pump (or the Fuel Filter on a gravity feed system) to the Carburetor (or Fuel Servo).
3. Purchase two new hoses: one to be used from the fuel pump (or the Fuel Filter) to the Fuel Flow Transducer and the other to be used from the Fuel Flow Transducer to the carburetor (or Fuel Servo). **There must be flexible hose in and out of the Transducer.** The hoses must meet TSO-C53a Type C or DFAA specification. **The new hoses must be the same size as the current hoses in the aircraft.** A source of fittings and fabricated hoses is:

Sacramento Sky Ranch Inc.
 (916) 421-7672
 Fax: (916) 421-5719

OR

Varga Enterprises Inc.
 (602) 963-6936
 FAX: (602) 899-0324

4. Mount the Fuel Flow Transducer in the fuel line. **You must use the FT-90 Fuel Flow Transducer on a gravity feed system or for any engine over 300 H.P.** The FT-90 Transducer is marked "Model 231" on the top of the transducer. **If the Transducer is mounted within 6" of an exhaust pipe, the Flow Transducer must be wrapped with Fire Sleeving.**
5. **Read the Installation Instructions for important installation considerations.**

Drawn By: R.R.	<i>Electronics International Inc.</i> Installation of a Fuel Flow Transducer suspended in the fuel line <u>from the fuel pump to the carburetor or fuel servo.</u> Note: <u>Not applicable</u> for a fuel injected engine with a fuel return line (see D/N 0415941).		
Approved By: R.R.			
Scale: None			
Material:			
Next Assembly:			
P/N:	Date: 12/29/93	Rev: D: 7/2/02	D/N: 1229932

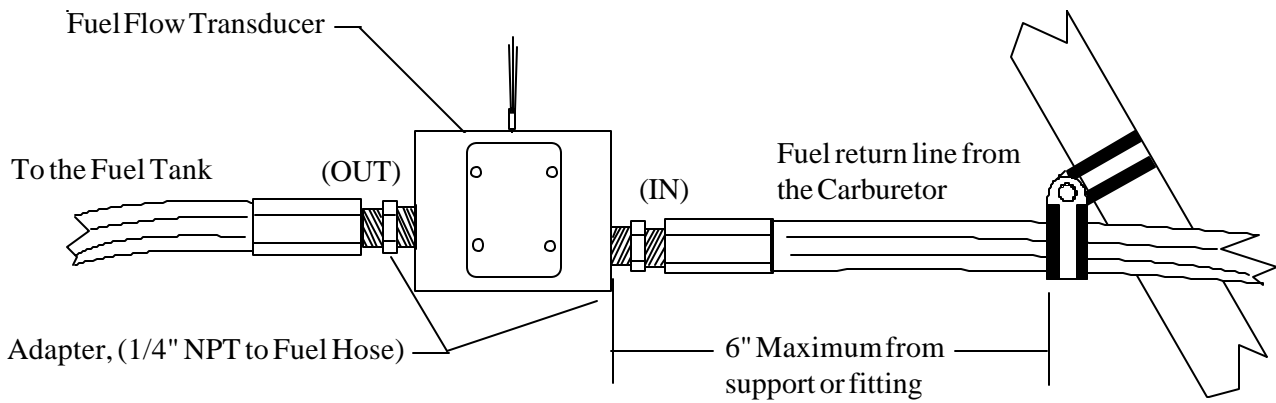

Mounting Procedure:

1. Find a convenient location within 6" of a hose support or fitting and away from any hot exhaust pipes to suspend the Fuel Flow Transducer. The hose support or fitting may be on the input or output line of the Flow Transducer.
2. Remove the return fuel hose which goes from the Carburetor to the Fuel Tank.
3. Purchase two new hoses: one to be used from the Carburetor to the Fuel Flow Transducer and the other to be used from the Fuel Flow Transducer to the Fuel Tank. **There must be flexible hose in and out of the Transducer.** The hoses must meet TSO-C53a Type C or DFAA specification. **The new hoses must be the same size as the current hose in the aircraft.** A source of fittings and fabricated hoses is:

Sacramento Sky Ranch Inc.
 (916) 421-7672
 Fax: (916) 421-5719

OR

Varga Enterprises Inc.
 (602) 963-6936
 FAX: (602) 899-0324

4. Mount the Fuel Flow Transducer in the fuel return line. **You must use the FT-90 Fuel Flow Transducer on any engine that has over 300 H.P.** If the Transducer is mounted within 6" of an exhaust pipe, the Flow Transducer must be wrapped with Fire Sleving.
5. **Read the Installation Instructions for important installation considerations.**

Drawn By: R.R.	<i>Electronics International Inc.</i> Installation of a Fuel Flow Transducer suspended in the <u>fuel return line</u> from the carburetor to the fuel tank. Note: <u>Only applicable</u> for installation on aircraft with a fuel return line from the <u>Carburetor</u>.		
Approved By: R.R.			
Scale: None			
Material:			
Next Assembly:			
P/N:	Date: 10/15/94	Rev: A: 7/2/02	D/N: 1015941

To the Flow Divider

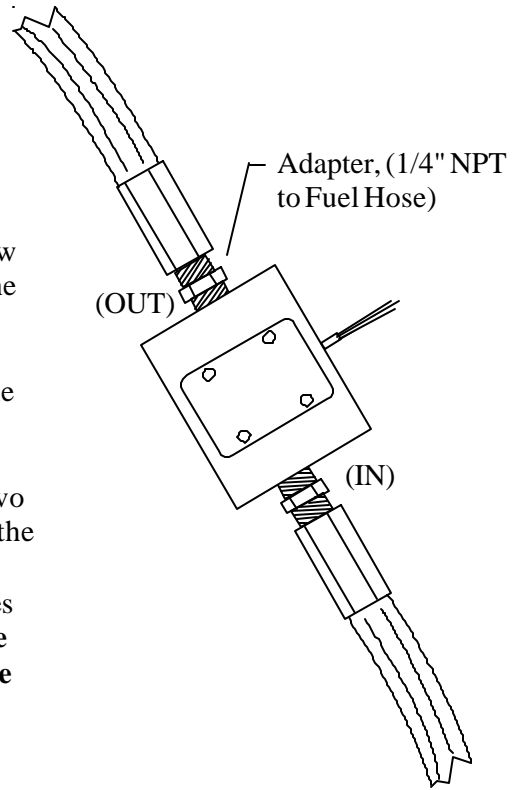

Mounting Procedure:

1. Find a convenient location between the Fuel Servo and Flow Divider and away from any hot exhaust pipes to suspend the Fuel Flow Transducer.
2. Remove the fuel hose which goes from the Fuel Servo to the Flow Divider.
3. Purchase two new hoses: one to be used from the Fuel Servo to the Fuel Flow Transducer and the other to be used from the Fuel Flow Transducer to the Flow Divider. **There must be flexible hose in and out of the Fuel Transducer.** The hoses must meet TSO-C53a Type C or D FAA specification. **The new hoses must be the same size as the current hose in the aircraft.** A source of fittings and fabricated hoses is:

Sacramento Sky Ranch Inc.
 (916) 421-7672
 Fax: (916) 421-5719

OR

Varga Enterprises Inc.
 (602) 963-6936
 FAX: (602) 899-0324

From the Fuel Servo

4. Mount the Fuel Flow Transducer in the fuel line. **You must use the FT-90 Fuel Flow Transducer on any engine over 300 H.P.** If the Transducer is mounted within 6" of an exhaust pipe, the Flow Transducer must be wrapped with Fire Sleeving.
5. **Read the Installation Instructions for important installation considerations.**

Drawn By: R. R.	<i>Electronics International Inc.</i> Installation of the Fuel Flow Transducer suspended in the fuel line <u>between the Fuel Servo and the Flow Divider.</u> Note: Only applicable for installation on aircraft with a fuel return line from the Fuel Servio.		
Approved By: R.R.			
Scale: None			
Material:			
Next Assembly:			
P/N:	Date: 4/15/94	Rev: B: 7/2/02	D/N: 0415941